

Belgacom Regulatory Cost Model 2010

General Description

Authors:

DECHEVRE Agnès

DESTAILLEUR Laurent

DIEU Peter

DOOMS Françoise

GABRIELS Niels

LINGURI Philippe

MEERSMAN Raf

PASCUAL USTARROZ Isabel

PEETERS Patrick

ROOSE Dirk

XIN Xiaofeng

VERVLOESEM Erik

TABLE OF CONTENTS

1	GENERAL DESCRIPTION	5
2	MODEL ALLOCATION STRUCTURE	7
3	COST BASE	12
3.1	Périmètre des coûts inclus dans le modèle	12
3.1.1	Coûts inclus dans le modèle	12
3.1.2	Coûts exclus du modèle.....	12
3.2	Organisation	13
3.3	Répartition du périmètre des coûts entre le module SRW et le module Network / IT	14
3.4	Assets revaluation.....	15
3.4.1	Decision tree	15
3.4.2	Methods used to reevaluate the network assets	15
3.4.2.1	Price Indexation.....	16
3.4.2.2	Inventory	17
3.4.2.3	Keep as it is.....	17
3.4.2.4	Index Based on a fixed PPC.....	17
3.4.2.5	Price Indexation for mobile assets.....	18
3.4.2.6	Asset valuation based on the Belgacom Reference Offer tariffs.....	18
3.4.2.6.1	Method background and rationale	18
3.4.2.6.2	Method description	18
3.4.2.6.3	Scope	18
3.4.2.6.4	Method implementation	19
3.4.2.6.5	Exceptions to the generic implementation	20
3.4.2.6.6	BIPT BRxx tariffs as base for asset valuation	21
3.4.2.6.6.1	BRUO	21
3.4.2.6.6.2	Blocks and tie cables	21
3.4.2.6.6.3	BROBA rental per end-user line.....	22
3.4.2.6.6.3.1	Active part	22
3.4.2.6.6.3.2	Transport rental ATM.....	22
3.4.2.6.6.4	BROBA ATM transport.....	22
3.4.2.6.6.5	BROTSoLL.....	23
3.4.2.6.6.6	WBA VDSL2 end user line.....	23
3.4.2.6.6.6.1	Passive part	23
3.4.2.6.6.6.2	Active part	23
3.4.2.6.6.7	WBA transport	24

3.4.2.6.6.8	BROTSoLL Ethernet	24
3.4.2.6.6.8.1	BROTSoLL Ethernet model for 10 or 100 Mbps lines	25
3.4.2.6.6.8.2	BROTSoLL Ethernet model for 1 Gbps lines	25
3.4.2.6.7	Non regulated tariffs as base for asset valuation	25
3.4.2.6.7.1	Adapted unicast price model for multicast	25
3.4.2.6.7.2	Local Tail Explore	26
3.4.2.6.7.3	Incremental intercity model	26
3.4.2.6.8	ATM equipment asset valuation	27
3.4.2.6.8.1	CAPEX Costing of the VP switching component	27
3.4.2.6.8.1.1	Elimination of IT, Overhead and backhaul components in BIPT tariffs	27
3.4.2.6.8.1.2	Calculation of ATM costs (CAPEX & OPEX)	32
3.4.2.6.8.1.3	Elimination of ATM OPEX costs	32
3.4.2.6.8.2	CAPEX Costing of the ATM access component	32
3.4.3	TAM: Tilted Annuity Method	32
3.4.3.1	Theory	32
4	SRW STREAM	35
4.1	Allocation of the support costs	35
4.2	Allocation of Retail costs	36
4.2.1	Determination of the retail cost perimeter	36
4.2.2	Introduction of 2 cost type dimensions	37
4.2.2.1	Dimension VAR_TYPE	37
4.2.2.2	Dimension PS_TYPE	38
4.2.3	Determination of var_type qualifications	38
4.2.3.1	Var-fix determination of retail organisational groups	38
4.2.4	Product allocation of NON_PRODUCT_SPECIFIC retail costs	39
4.3	Allocation of CWS (Customer Whole Sale Division) related costs	40
5	NETWORK&IT OPEX DE-AGGREGATION	42
5.1	Common OPEX allocation stream IT and Network	42
5.1.1	GL61 accounts – Services and Other Goods (SOG)	42
5.1.2	GL62 accounts – Wages costs	43
5.1.3	GL60 accounts – Material Out of Stock	46
5.2	Allocation of teamgroups to NW or customer-related activities	51
6	IT STREAM	57
6.1	IT delivery	57
6.1.1	IT Sub-Model: Introduction	57
6.1.2	Data sources: IT Inventories and Reporting Systems	58

6.1.2.1	Infrastructure and Hardware Inventory:	58
6.1.2.2	Internal IT Databases:	59
6.1.2.3	Reporting Systems:	59
6.1.3	Modules and Objects composing the IT Sub-Model	59
6.1.3.1	IT Servers	59
6.1.3.2	Storage	61
6.1.3.3	IT Interconnection	61
6.1.4	Allocation Process for IT Assets and Operational Costs:	62
6.1.4.1	IT Assets	62
6.1.4.2	Operational Costs:	70
6.1.5	Applications to Constellations	70
6.2	Allocation of IT constellations	71
7	NETWORK STREAM.....	71
7.1	A layered allocation model.....	72
7.2	From Assets to Network Stage Functions.	76
7.3	End User Services	81
7.4	Network services of the passive infrastructure layer : NLS1.0.....	84
7.4.1	Definition	84
7.4.2	Usage of the passive infrastructure	85
7.4.3	Contributors to the passive infrastructure layer	86
7.5	Network services of the transmission infrastructure (NLS2_0)	87
7.5.1	Definition	87
7.5.2	Usage of the transmission infrastructure	89
7.5.3	Contributors to the transmission infrastructure	90
7.5.3.1	Local Tail	90
7.5.3.2	Transport Segments.....	91
7.6	Network services of the packet based infrastructure (NLS2_1)	91
7.6.1	Definition	91
7.6.2	Usage of the data packet infrastructure	93
7.6.3	Contributors to the data packet infrastructure services.....	94
7.7	Network services of the IP infrastructure layer (NLS3-IP).....	98
7.7.1	Scope	98
7.7.1.1	Public services.....	98
7.7.1.1.1	IP_collection.....	98
7.7.1.1.2	Public_IP_switching.....	99
7.7.1.2	Private services	99
7.7.1.2.1	Private_IP&Ethernet_Extension	99
7.7.1.2.2	NLS3_Private_IP&Ethernet_Routing.....	100

7.7.2	Contributors to the Network Layer 3 services	101
7.7.2.1	Components (Physical equipment).....	101
7.7.2.2	Lower layer services.....	102
7.8	Network Services of the application layer	103
7.8.1	Definition	103
7.8.2	Usage of the application layer	104
7.8.3	Contributors to the application services	117
7.9	Allocation of Network and customer-related activities of 50_SDE :.....	123
8	ANNEX I: SRW FLOW ACRONYMS	128
9	ANNEX II: NETWORK AND IT FLOWS ACRONYMS	129

1 General description

Le département REG (Group Regulatory Affairs) assure la préparation des comptes séparés et opère le modèle d'élaboration des coûts sous-jacent à la production des coûts séparés et utilisé dans différents autres dossiers réglementaires. Conformément aux recommandations de la Commission Européenne, la totalité des coûts issus de la comptabilité générale (statutaire) est prise en compte dans le cadre de l'élaboration des comptes séparés et du modèle de coûts sous-jacent, à l'exception des comptes 65, 67 et des coûts des autres comptes écartés du périmètre. Les coûts utilisés dans l'exercice de modélisation sont directement issus du système SAP qui administre la comptabilité générale de Belgacom S.A. Les comptes statutaires ont fait l'objet d'un audit statutaire en 2011 effectué par Deloitte, Réviseurs d'Entreprises. Le collège des réviseurs d'entreprises a émis une attestation sans réserve des comptes annuels.

Les comptes séparés émanent des flux d'allocation de coûts réseau, IT et des flux SRW (Support, Retail and Wholesale) du système de comptabilisation des coûts de Belgacom, incluant le périmètre issu de la comptabilité générale ainsi que le coût du capital repris dans ces deux modules.

Le schéma suivant représente la structure du système de comptabilisation des coûts et mentionne les flux principaux. L'entièreté des éléments de coûts présents dans les flux est intégrée dans un logiciel (INCA) qui en effectuant des tests de validations empêche toute possibilité de double comptage ou d'attribution multiple.

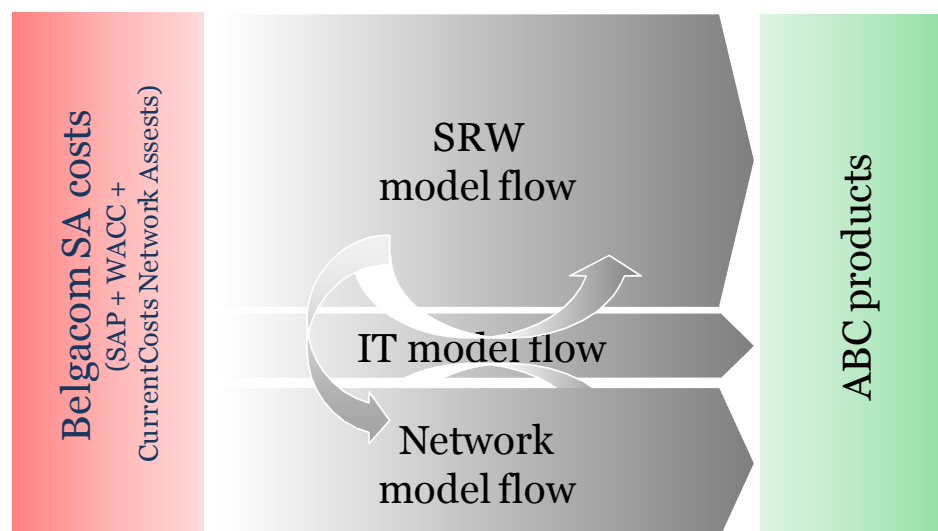

Figure 1

Les flux d'allocation de type SRW reprennent les coûts commerciaux et les autres coûts directs ou indirects qui ne sont pas repris dans les flux d'allocation « réseau » ni dans les flux « IT ».

Les flux « réseau » et les flux « IT » quant à eux, traitent tous les coûts en matière de réseau et de technologie de l'information.

Faisant partie d'un seul et même modèle intégré et prenant leur source à une seule base de coûts , les flux d'allocation « SRW » , « réseau » et « IT » sont vérifiés par l'outil de gestion de modèle INCA assurant l'absence de double comptage et la traçabilité des données calculées jusqu'aux données du système SAP.

Le modèle d'élaboration des coûts de revient par produit suit l'approche "top-down".

2 Model Allocation Structure

This section provides with a global view on the allocation structure of the model by walking through the major allocation flows and introducing the major building blocks and concepts in the model.

The following Figures will be the supporting tools for such discovery walk, where the major modules constituting the model as well as the global allocation flows among them are shown. The differentiation between SRW , IT and Network flows is also illustrated in the exhibit.

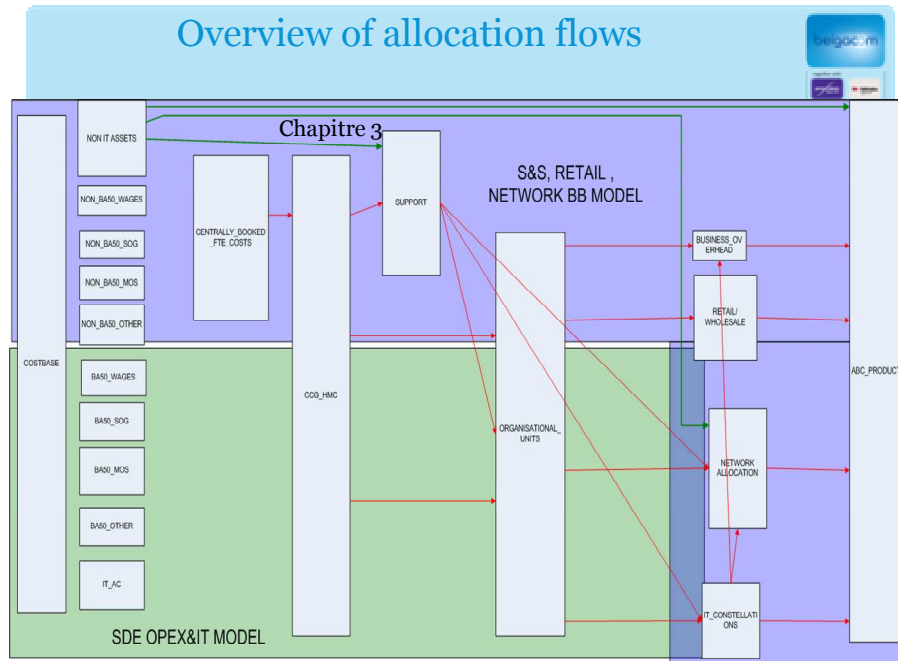

Overview of allocation flows

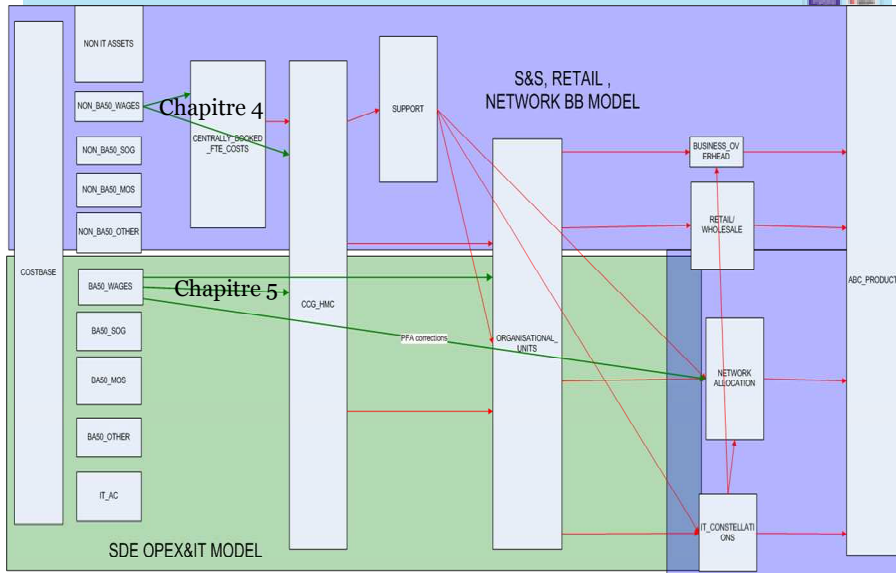

Overview of allocation flows

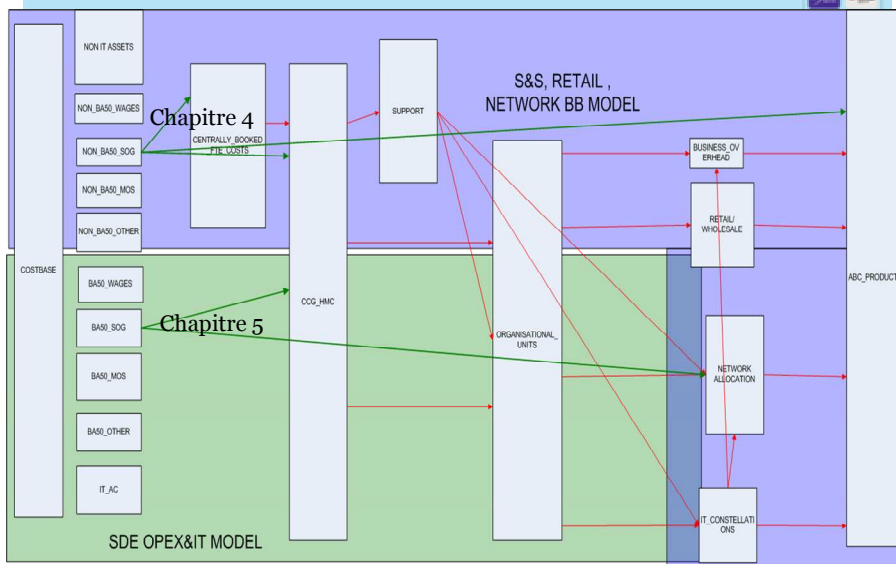

Overview of allocation flows

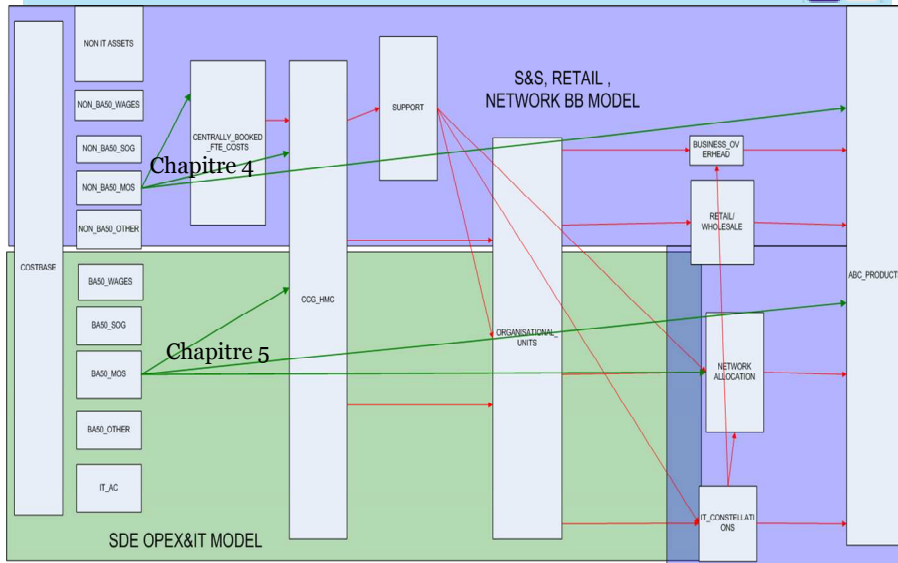

Overview of allocation flows

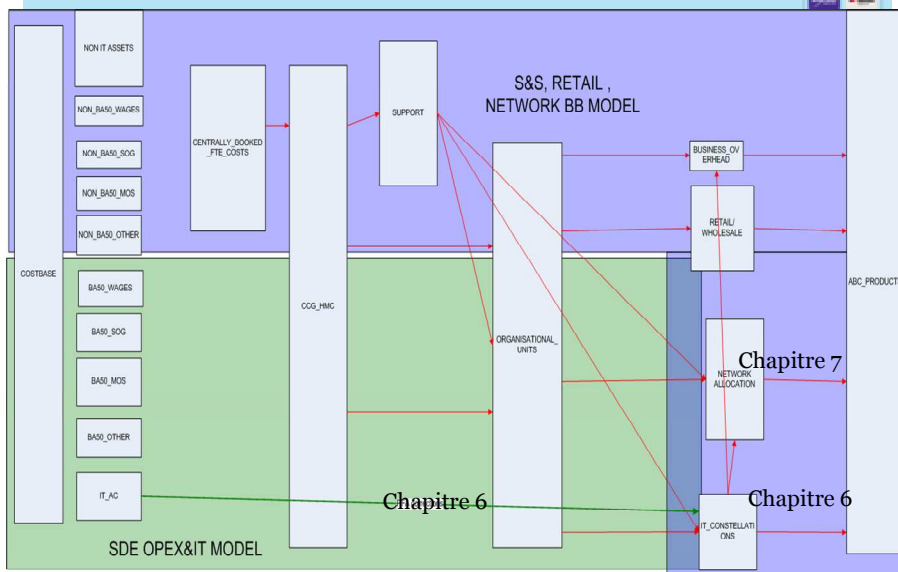

The overall objective of the model is allocating all the costs present in the cost base to the ABC products which have been defined by REG.

Therefore, the cost base constitutes the foundation of the model.

Further, the model allocation process can be subdivided into three main streams, SRW, IT and Network.

The SRW stream has as objective to allocate all costs that are not part of the Network or IT model towards the ABC products.

The IT and Network streams, although having completely separated CAPEX basis, both share a common OPEX source since in the current organisation there are no specific cost centers for IT and non IT operational costs. Therefore, the first action to tackle is the distribution of these aggregated costs into their respective IT and Network components. Regarding the Network OPEX costs, this “Network&IT OPEX de-aggregation” stage also delivers a further division of the Network related OPEX costs into expenses contributing to “Network activities” and expenses directly attributable to the Network. The detailed process followed to achieve such de-aggregation is explained in the chapter 5.

Once this distinction has been made, the IT and Network streams can be dealt with independently.

The IT stream, even if it is a true model on its own, has been compacted into two main steps in the model:

- The IT delivery module processes the IT specific CAPEX and OPEX costs and distributes them into the IT constellations. The full description of this complex step can be found under the chapter 6.1.
- The allocation of the IT constellations into the different activities supported by IT. See chapter 6.2 for a comprehensive explanation on the subject.

The Network stream has also been squeezed into two main consecutive stages:

First, the allocation of the Network Primary Activities into the Network objects (ref to chapter 7.9).

And second, the distribution of all the costs attributable to the network - SRW , IT constellations and OPEX and CAPEX network costs - into the ABC products, which is carried out by the Network block. The chapters 7.1 to 7.8 describe in depth this stage.

At this time the model has been fully covered in this paragraph, however, from a functional perspective, there is still a concept that requires being introduced: the “Submodel”.

The concept consists of taking a portion of the overall model - namely a number of neighbouring model modules and their relating allocations - and treating it externally in an

independent model, the so called submodel. The processed submodel is inserted back into the model as a sort of “black box”.

The notion of sub-model is introduced due to limitations in the tool used by Belgacom to put together, process and generate reports on the model, INCA, which were hit by the high complexity degree of the Belgacom Regulatory Model.

The advantage of this way of proceeding, and main reason for its introduction, is reducing the complexity of the model to remain within the operational limits of INCA. The drawback is the loss of detail in the model regarding the aspects treated in the sub-model. In any case, the complete allocation process is kept and detailed model reports are always possible but at sub-model level only, in a stand- alone manner.

This drawback is the key element in the decision of which portion of the model is processed within the submodel. The submodel should only treat parts of the model which do not deal with Belgacom core activities, so that the loss of the detail in the final model and subsequent reporting is tolerable. In the 2010 model, the model elements dealt with in the sub-model are:

- Network&IT OPEX de-aggregation
- IT delivery

3 Cost Base

3.1 Périmètre des coûts inclus dans le modèle

3.1.1 Coûts inclus dans le modèle

Les coûts inclus dans le modèle sont les comptes de charges opérationnelles, c'est à dire les comptes 60 à 64 de la comptabilité générale, ainsi qu'une partie des comptes 66 et 69.

Le compte 60 "achats de matériel" comprend principalement des achats de matériel télécom (modem ADSL, terminaux, câbles, cartes, mobiles, ...) et de fournitures (cpe, ...) et des variations de stocks.

Le compte 61 "services et biens divers" comprend principalement les charges liées au trafic (notamment les redevances d'interconnexion) et les charges de maintenance, d'énergie, de locations, de publicité, de représentation, de consultants, de déplacements.

Le compte 62 correspond aux charges de personnel.

Le compte 63 correspond aux dotations aux amortissements, aux provisions et aux réductions de valeur.

Le compte 64 regroupe les autres charges opérationnelles, parmi lesquelles se retrouvent principalement les éléments suivants : abandons de créances, précompte immobilier et taxes sur pylones.

Le compte 66 reprend le montant de charges exceptionnelles correspondant au montant PBS (Pension Back Service) accepté par l'IBPT dans le cadre de l'offre BRIO.

Le compte 69 reprend le montant d'affectations et prélèvements correspondant à la participation du personnel dans le bénéfice de l'exercice (bonus collectif).

Par ailleurs, le compte 72 – "Production immobilisée" vient diminuer la base des coûts pour annuler les charges liées à la production immobilisée et éviter un double comptage avec les charges d'amortissements correspondantes.

Au périmètre issu de la comptabilité générale s'ajoute le coût moyen pondéré du capital (WACC) de 9,61% pour Belgacom fixe et 10,05% pour Belgacom mobile.

3.1.2 Coûts exclus du modèle

Les autres charges sont exclues du modèle. Il s'agit des comptes 65 à 69 de la comptabilité générale, excepté une partie des comptes 66 et 69.

Certaines charges sont exclues car considérées comme n'ayant pas de lien de causalité avec les produits et les activités. C'est le cas des charges exceptionnelles qui n'ont pas été reprises dans l'offre BRIO (compte 66) et des charges fiscales (comptes 67 et 68).

D'autres charges sont exclues du fait qu'elles sont déjà prises en compte dans le coût moyen pondéré du capital. Il s'agit des charges financières (compte 65) et des charges de dividendes (compte 69).

Il s'agit ici des coûts exclus du modèle en amont (c-à-d. lors de la délimitation du périmètre de coûts issus de la comptabilité générale) auxquels il faudra ajouter les coûts qui sont exclus en aval du modèle (c-à-d. lors du processus d'allocation, par exemple les coûts de support relatifs aux filiales).

3.2 Organisation

2010 is the first year where we have a full convergence between the Fixed Line, Mobile line, Telindus (except the international part) and Skynet activities. The personnel of the former Mobile, Telindus and Skynet subsidiaries are structured in a converged functional organisation. Compared to 2009 the organisation has been kept quite stable. The costs of the former subsidiaries have been integrated within the Fixed line cost center structure. However due to this integration new cost centers were necessary for e.g: roaming, Telindus outsourcing projects, Prox. pylones.... The BDV (Business Development&Planning) departments of CBU and EBU and also CMI – Customer & Marketing Intelligence department of CBU became part of Strategy.

The organisational structure is laying upon 4 pillars:

- Consumer Business Unit (CBU) has the responsibility over the residential customers
- Enterprise Business Unit (EBU) has the responsibility over the professional customers
- Service Delivery Engine (SDE) centralises network and IT services
- Staff and support (S&S) groups all horizontal functions sustaining the Group activities

For information, find below the organisation as on January 1, 2010 :

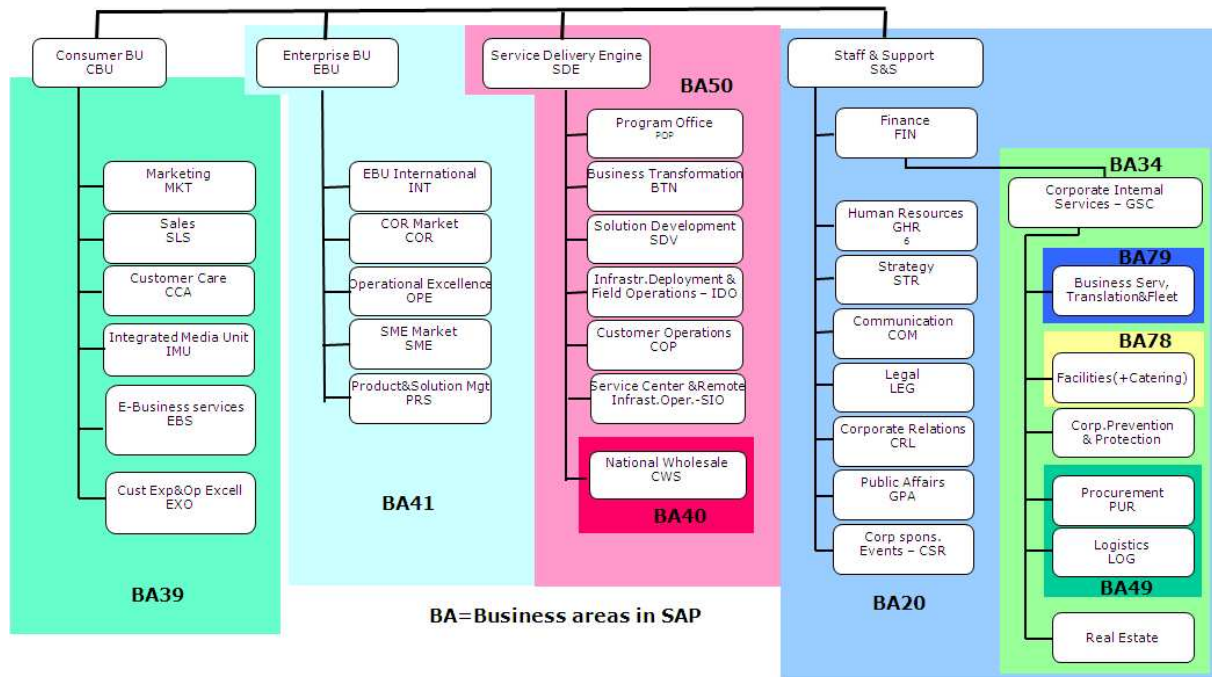

Figure 2

- This organisation has a clear split between the residential and professional customers by creating the division Consumer and Enterprise Business Units.
- The Service Delivery Engine brings together Network and IT services (formerly named ITN) , Customer Operations (COP), Program Office (POP) and Carrier Wholesale (CWS). The content of these blocks remains the same meaning that network and IT services are treated within the Network / IT flow.
- Within Staff & Support the content (FIN, GHR, STR, LEG, COM....) remains the same. Corporate Internal Services grouping internal services like Fleet, Facilities, Prevention&Protection, Procurement....falls under the responsibility of FIN, the Financial department.

3.3 Répartition du périmètre des coûts entre le module SRW et le module Network / IT

Le périmètre des coûts est réparti par le département REG entre les flux d'allocation de coûts réseau, IT et SRW en s'assurant que les données de coûts issues de SAP soient complètes et ne contiennent pas de doublons. Comme mentionné dans la description générale, le flux Network / IT alloue tous les coûts et investissements en matière d'informatique et de réseau alors que le flux SRW alloue tous les autres coûts et investissements.

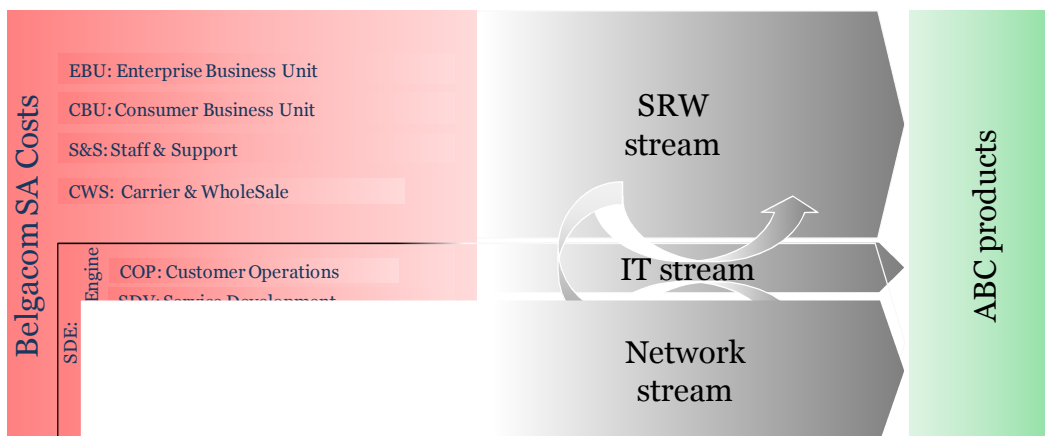

Figure 3

La répartition du périmètre des coûts entre les flux Network / IT et SRW est réalisée comme suit:

- All departments within SDE are treated within the Network / IT flow.
- Les provisions relatives aux taxes sur équipements télécom qui sont enregistrées au niveau de SDE Mgmt sont réparties entre les flux sur base des classes d'actifs sous-jacentes.
- All other costs, not mentioned above are treated within the SRW flow namely the divisions CBU (Consumer Business Unit) and EBU (Enterprise Business Unit), CWS (Carrier Wholesale) and Staff & Support. The Staff & Support division comprises different departments. Firstly, STB (Services to Business) which includes Headquarters, Legal, CSR

(Corporate Social Responsibilities), COM, Public Affairs, Secretary General and CRL (Corporate Relations). Then we have departments like Finance, Group Human Resources, Strategy and finally GSC (Corporate Internal Services) for departments like Real Estate, Business Services, Facilities, Prevention & Protection, CSM (Corporate Sourcing & Supply Change).

- En ce qui concerne les investissements (amortissements et coût moyen pondéré du capital), la répartition entre les flux SRW et Network / IT est effectuée sur base d'une analyse des classes d'actifs: les actifs IT et réseau enregistrés au niveau de la division SDE sont traités dans le flux Network / IT tandis que tous les autres actifs (bâtiments, installations énergie, CPE,...) sont traités dans le flux SRW.

3.4 Assets revaluation

3.4.1 Decision tree

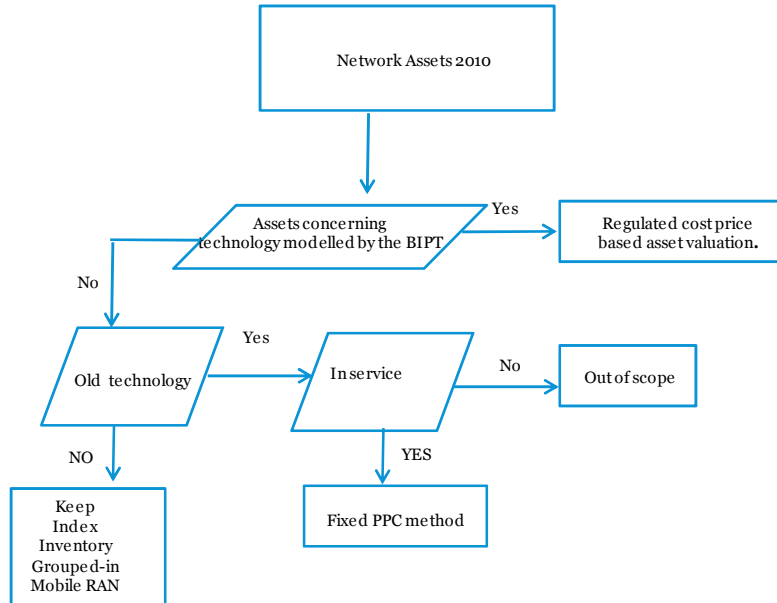

3.4.2 Methods used to revalue the network assets

The regulatory framework clearly states that the cost accounting systems of operators being declared as dominant on relevant markets must be set based on Current cost accounting for the network costs.

The network & IT flows within the top down model 2010 calculate the current costs for the network related assets. Current costs have been computed as explained hereafter.

There are five methods to evaluate the current value of the network: reassessment of the current inventory, price indexation, by default “keep everything as it is”, index based on a fixed PPC and regulated cost price based. For old assets concerning technology still in service we use a method

based on a fixed PPC2007. Each of these methods requires its own set of inputs. It is mainly the availability (or lack) of input which dictates the choice of the method. Nevertheless each method has its advantages and disadvantages with respect to the others.

The inventory and price indexation methods assume that network departments replace the equipment of its assets by equivalent equipment. The notion of equivalent is quite fuzzy. An engineer would tell you that over time there are always more functions integrated in new equipment and that they are always more cost-effective. It makes the comparison between different generations of equipment difficult. The notion of equivalent has therefore been addressed through the term Modern Equivalent Asset (MEA). The assets must be replaced by their MEA. The MEA is the replacement cost of the technology expected to be in place within the planning horizon. Note that this notion takes into account the introduction speed of a new technology in the network. If network departments plan to have replaced 50% of an old technology by a new one within the planning horizon, it makes no sense to simulate the costs with higher percentages because the planning takes into account the availability of the resources to carry out the work.

Find hereafter the rules that have been used:

- ❑ Technology still in procurement: use current price, e.g. SDH equipment, DWDM equipment
- ❑ Technology to be replaced within the planning horizon: use current price of the modern equivalent asset, e.g. some PDH line system equipments are replaced by SDH equivalents.
- ❑ Obsolete technology: use current price of the modern equivalent asset, e.g. the HDSL technology for high speed services on copper replaces the less cost-effective HDB3 technology.
- ❑ Technology grouped in : those assets will be revaluated by another asset concerning the same technology
- ❑ Old technology not anymore in service : those assets are set out of scope and will not be revaluated
- ❑ Old technology still in service (in maintenance mode) ; those assets are revaluated by an index method based on a fixed PPC instead of index or inventory method . Old assets revaluated by keep will keep the CAV value as GRC
- ❑ BIPT regulated technology : use the BIPT regulated cost price to calculate the annual capital cost

3.4.2.1 Price Indexation

This is the most straightforward approach, provided historical costs are available. The investments for each year (from 1981 on) are multiplied by the price index of the year concerned. The price index is equal to the ratio of the current price to the historical price of the equivalent service/product.

The method is refined by defining price indexes depending on the nature of the cost. This is particularly true when costs of a different nature experienced a different price evolution. Three different types of price indices have been defined: the labour index, the indices for services delivered by external companies and the material index. Note that indices for services supplied by external companies vary according to the asset involved. For example, services supplied by external companies related to cable assets, are in fact outsourced labour costs for trenching and cable installation. In such case, a labour index has been applied. Other external services less labour intensive are resulting in other price indices, such as a fibre cable index.

3.4.2.2 Inventory

This is the best method to reflect accurately the price of assets currently in service in the network. The revaluation is merely performed by multiplying the volume of each specific type of equipment currently deployed in the network by its average current unit cost. The current unit costs are based on the prices defined in the current frame agreements we have with our suppliers.

In terms of inputs it is the most demanding method. It requires an extensive inventory of equipment.

The inventory method has been used for data, switching, transmission and access equipment. Switching data is based on the inventory reports delivered by the engineering service. Transmission and access data are obtained from the technical database ITR. Data inventories are obtained from field operational tracking sheets.

3.4.2.3 Keep as it is.

The “keep as it is” method is merely what its name says. We keep the price we have in the historical accounting books. This method is only valid for costs with a very short depreciation period or for software intensive products. For the latter we assume that on the one hand software development is labour intensive but on the other hand the rapidly evolving programming environment improves the productivity compensating for the higher labour cost. This results in a stable software price. Another practical reason to select the “Keep as it is” method is the amount booked on the asset. If this amount is small, the method has also been applied. In this particular case, the effort to collect all the information about the cost evolution outweighs the impact on the service costs.

3.4.2.4 Index Based on a fixed PPC

Old technology still in service (in maintenance mode) ; those assets are revaluated by an index method based on a fixed PPC.

If Belgacom has done some investments for keeping those technologies in service, we take those investments also into account.

If Belgacom has done some great retirements, the revaluation method is revised.

□ Formula :

$$GRC_{yearN} = [(GRC_{yearN-1}) * (1 + fixedPPC 2007)] + investment sYearN$$

3.4.2.5 Price Indexation for mobile assets

The investments for each year are multiplied by the price index of the year concerned. The price index is equal to the ratio of the current price to the historical price of the equivalent service/product.

The historical series of indexes for each asset has been derived from the yearly percentage price change determined in the **BIPT model 2008**.

Formula :

$$Index\ year = (1 + (ppc\ year))^* (1 + (ppc\ year - 1))^* (1 + (ppc\ year - 2))^* \dots\dots\dots$$

3.4.2.6 Asset valuation based on the Belgacom Reference Offer tariffs

3.4.2.6.1 Method background and rationale

The market for fixed telecommunication services, the related technologies and the competition have evolved through the years leading to the current situation where the vast majority of the telecom services provided by the Belgacom's access and area backbone networks are regulated. This regulation has been enforced, amongst other initiatives, by clearly specifying the services and applying regulated tariffs, as reflected in the Belgacom Reference Offers (BRUO, BROBA, BROTSoLL, BROTSoLL Ethernet and WBA).

Since the regulated tariffs are cost oriented and determined by bottom-up costing models, it is reasonable to use the direct CAPEX component of these prices to calculate the annuity of the assets addressed by the Belgacom Reference Offers.

3.4.2.6.2 Method description

All the assets concerned by the technologies covered by the Belgacom Reference Offer models (BRxx), namely BRUO, Block&Tie cables, BROBA, BROTSoLL, BROTSoLL Ethernet and WBA, are valued by applying the direct CAPEX component of the relevant BRxx tariff to the appropriate volumes extracted from the Belgacom inventories.

3.4.2.6.3 Scope

The technologies to be valued by this method, since they are covered by the Belgacom Reference Offers, are:

- Copper infrastructure: including trenching, ducting and optical copper cable.
- Fiber infrastructure: including trenching, ducting and optical fiber cable.
- (D)WDM
- PDH/SDH
- ATM
- xDSL: including ADSL, ADSL2+ and SDSL
- VDSL
- Ethernet

However, some parts of the networks deployed with the above mentioned technologies are not covered by the BIPT tariffs for they provide non regulated services. Consequently they cannot be valued by means of the regulated tariffs.

These services are:

- Any service provided by the Belgacom express network layer, also called intercity network.
- Multicast services, namely broadcast TV.
- Access lines for the Explore customers.

The chosen alternative for valuing the network sections providing the non regulated services has been the development of specific models in order to determine applicable direct CAPEX unit prices.

3.4.2.6.4 Method implementation

- *Inputs*
 - *Broken down tariffs*
 - *Broken down tariff based on the BIPT BRxx models*

By analyzing each of the current BRxx models, the direct CAPEX component of each product of each tariff has been isolated. Further, this constituent has been broken down into all its applicable technological contributors, so that a unit price per technology, per product and per tariff is extracted (**Figure 4**).

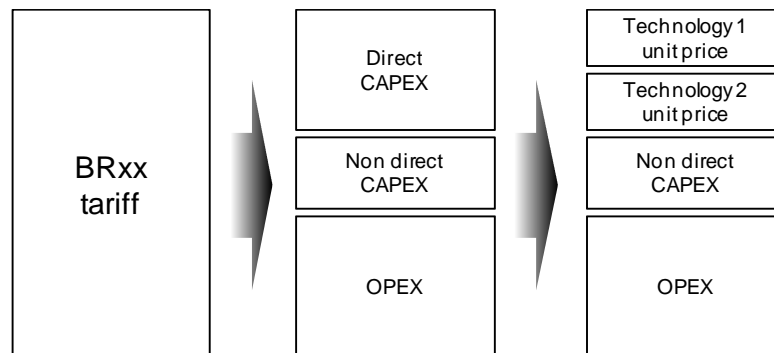

Figure 4: Conceptual description of the BRxx tariff breakdown.

Note: There is no relation between the size of the components and any broken down BRxx tariff.

Although the above described process is applicable to the majority of the BRxx models, there is an exception to the rule, the BIPT BROBA transport model. A complete explanation on how this tariff is broken down, in order to obtain the direct CAPEX component, is given in paragraph 3.4.2.6.8.

- *Broken down tariff for network areas not under the BIPT BRxx models scope*

For those areas of the network not within the scope of the BIPT models, specific models have been developed in order to derive applicable broken down tariffs. These models have been built up on similar principles to those applied in the models developed by the BIPT. Whenever possible the actual BIPT tariff components have been re-used and existing BIPT models have been adjusted so that the obtained results are as comparable to those of the BIPT models as possible.

- *Volumes*

The volumes (demands) of all the telecommunication services utilizing the technologies subject to this valuation methodology are extracted from or determined based on Belgacom inventory systems.

- *Valuation*

- In a first step, each pair, line, VP, link or VLAN present in the volumes is valued by applying each and all of the technology unit prices of the relevant BRxx tariff. In this way, each telecom service's individual contribution to the assets valuation is calculated.
- Finally, all the individual contributions are summarized per network asset, obtaining the final asset annuity.

3.4.2.6.5 Exceptions to the generic implementation

Although the above described process is applicable to the majority of the tariffs, there are two exceptions to the rule.

The breakdown of the BIPT BROBA transport tariff is made differently. A complete explanation on how this tariff is broken down, in order to obtain the direct CAPEX component, and how it is applied is given in paragraph 3.4.2.6.8.

Second, the AC2_20106 fibre infrastructure annuity is not the sum of the contributions calculated as per the above procedure, since by doing so the annuity of this asset would be widely overstated. This circumstance occurs because the models developed by the BIPT to derive the BROTSOLL and WBA transport tariffs have both included the costs of the complete Belgacom fibre infrastructure. As a result, the fiber infrastructure CAPEX component of each tariff does not only allow recovering the cost of the optical infrastructure required to provide the service under the scope of the tariff but the complete fiber infrastructure.

Therefore, aiming to value the AC2_20106 fibre infrastructure in the most accurate way, the asset annuity is calculated as sum of the following cost elements:

- Access network fiber infrastructure costs: sum of all the contributions calculated in the generic valuation process.
- Backbone fiber infrastructure costs related to the regulated parts of the network: fiber infrastructure annuity calculated in BROTSOLL.
- Costs of the backbone fiber infrastructure dedicated to the non regulated elements of the network, namely the express layer: fiber infrastructure incremental costs required to support the intercity network.

Although the very last step of the process is not valid for the fiber infrastructure asset, all the other steps have been followed, since the individual contributions will be used in the costs allocation within the network model.

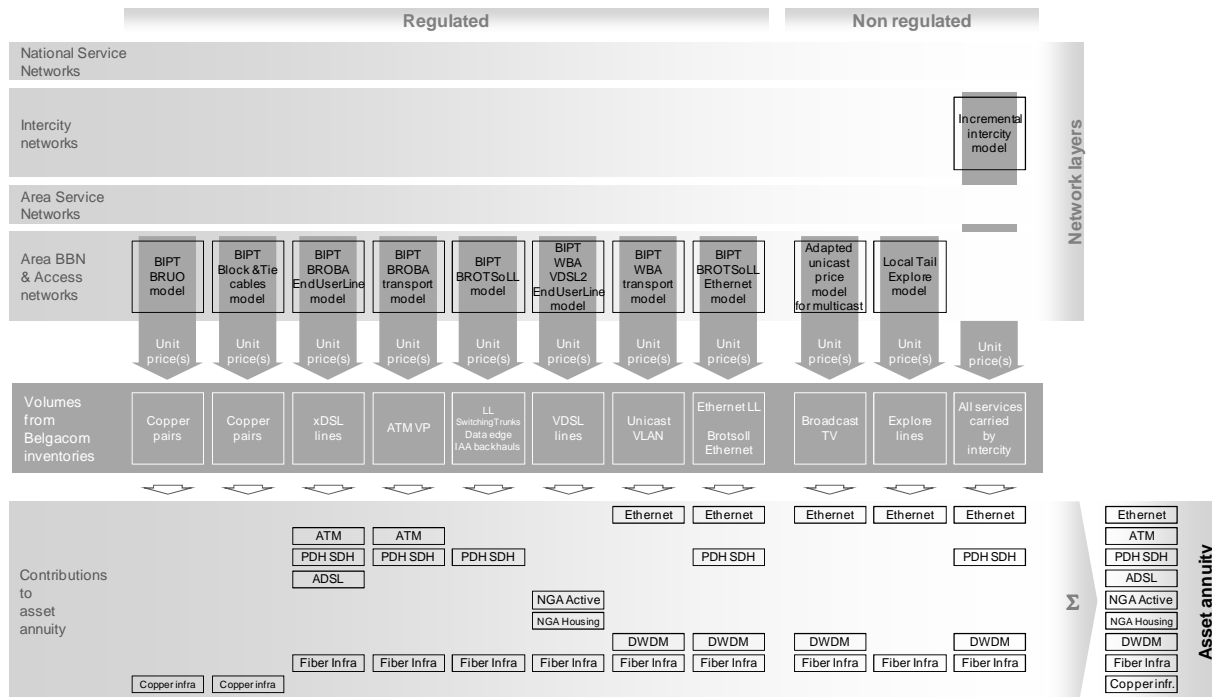

Figure 5: BRxx based valuation method. Scope and implementation.

3.4.2.6.6 BIPT BRxx tariffs as base for asset valuation

3.4.2.6.6.1 BRUO

The BIPT BRUO model (decision of 10/11/2010) has been used to value assets included in the asset AC2_20104 Copper infrastructure. Those assets have been valued based on the unit direct CAPEX cost in the BRUO model and the number of pairs used. It includes mainly the cost of copper cables, trenching and street cabinets.

The current value of following assets has been calculated based on BRUO tariffs:

- Raw Copper, for PSTN/ISDN accesses, central site based broadband without voice accesses, local tails for leased lines type of connectivity, BRUO raw copper.
- Copper subloop, for street level based VDSL without voice accesses.
- Copper subloop testing cost, to ensure remote line testing of street level based VDSL without voices accesses. This cost is valued based on the unit direct CAPEX cost of the feeding network that can be derived from the BRUO tariffs (local loop, subloop).
- Copper splitter, to split narrowband and broadband signals for shared pairs. The shared pairs' inventory is the volume used to value the copper splitter

3.4.2.6.6.2 Blocks and tie cables

The BIPT Blocks and Tie cable model (decision 2/7/2008) has been used to value assets included in the asset AC2_20104 Copper infrastructure. This bottom-up model defines direct CAPEX prices for Main Distribution Frame blocks and for tie cables to other access network equipments.

The current value of following assets has been calculated based on Blocks and Tie cable tariffs:

- Copper local loop testing: internal cabling copper connectivity to perform remote testing of broadband without voice customer connections at the central site.
- Copper subloop testing: internal cabling copper connectivity for VDSL without voice customer connections at the street level.
- Continue raw and shared copper: internal cabling copper connectivity from Main Distribution Frame or broadband splitter equipment to other access equipments or collocated access equipments.

3.4.2.6.6.3 BROBA rental per end-user line

The BROBA rental fee per end-user line is split by BIPT between the active part and the transport rental ATM or Ethernet part. Note that this model is sometimes referred to as BROBA Bitstream.

3.4.2.6.6.3.1 Active part

The BROBA model (decision of 6/8/2010) has been used to value assets included in AC2_20102 ADSL. It is related to DSLAM and Main Distribution Frame space direct CAPEX costs.

The asset has been calculated based on the direct CAPEX part of the BROBA Bitstream tariff applied to ADSL, ADSL2+ and SDSL subscription volumes.

3.4.2.6.6.3.2 Transport rental ATM

Transport rental ATM refers to the cost of the backhaul line between the DSLAM and the ATM switch. These links are implemented as ATM over PDH/SDH which in turn is carried by the optical fiber infrastructure, therefore the cost is constituted by the following elements:

- ATM (AC2_20103 ATM equipment): it is valued as per BROBA transport description on paragraph 3.4.2.6.8.
- PDH/SDH (AC2_20109 PDH SDH equipment): BROBA takes the BROTSOLL model as reference pricing for this cost. Hence, the later model has also been used to value this cost element. The PDH/SDH links volume inputting this valuation comes from ITR, the Belgacom transmission network inventory.
- Optical fiber infrastructure (AC2_20106 fibre infrastructure): BROTSOLL is also the reference, as PDH/SDH underlying physical technology. Consequently the same volume as that of PDH/SDH is applicable. Note that this asset includes trenching, ducting and optical fiber costs.

3.4.2.6.6.4 BROBA ATM transport

This model regulates the service delivering ATM connectivity (virtual paths) between ATM switches. As mentioned in the former paragraph, the ATM services are always deployed as ATM over SDH, thus the following costs constituents emanate from this model:

- ATM cost

This cost relates to the function of the ATM network to provide switched Virtual Paths between a port of a local switch and another port of the same local switch (local VPs) or of an area switch (non local VPs). It is integrated in AC2_20103 ATM equipment.

This costing is based on the demand for xDSL (ADSL, ADSL2+ and SDSL) fast internet accesses and on the inventory of switched Virtual paths (local VPs, and non-local VPs) configured on the Belgacom ATM network, for all other virtual paths. Each virtual path is valued using the current BIPT BROBA VP tariffs (decision of 22/10/2008).

For xDSL fast internet accesses, the demand has been calculated based on the inventory of customers and DSLAMs per local exchange. Given the customer profile and the associated constant average usage (kb/sec), the total required bandwidth per virtual path ATM has been calculated.

The complete description of this tariff component, its calculation and use is given on paragraph 3.4.2.6.8.

- PDH/SDH: BROTSoLL is the reference tariff for valuing this cost. The volume of links to which this tariff is applied comes from ITR.
- Optical fiber infrastructure: as PDH/SDH.

3.4.2.6.6.5 *BROTSoLL*

The Belgacom Reference Offer for Terminating Segments of Leased Lines (BROTSoLL) regulates the complete PDH/SDH transmission network of Belgacom, with the exception of the highest hierarchy rings, the so called Intercity network or express layer. The current BIPT decision on this tariff dates from 10/3/2008.

The technologies covered by this reference offer and consequently to be valued through this tariff are:

- PDH/SDH (AC2_20109 PDH SDH equipment): covering the costs of the equipment of this technology delivering service to all the network hierarchies but the express level.
- Optical fiber infrastructure (AC2_20106 fibre infrastructure): values the physical infrastructure conveying the SDH signal. There are two sub-components, access and backbone, for the access network and the other parts of the network respectively.

Further, this service can in fact make use of the copper infrastructure on the access side in case of small bandwidth lines. However, these costs are embedded in the BRUO based valuation.

The valuation has been done by applying the above technologies direct CAPEX unit cost to all the links implemented over SDH under the BROTSoLL scope which are documented in ITR, the Belgacom transmission inventory system.

3.4.2.6.6.6 *WBA VDSL2 end user line*

3.4.2.6.6.6.1 *Passive part*

The BIPT WBA model (decision 10/11/2010) has been used to value the assets AC2_20108 NGA Housing as well as part of the asset AC2_20106 fibre infrastructure related to external fiber connectivity to the cabinet (Remote Optical Platform “ROP”).

For the valuation of AC2_20108 NGA Housing, the BIPT unit direct CAPEX cost has been applied to the number of VDSL2 subscriptions. The main elements included are the cost of the ROP, the copper connectivity to the street cabinet and powering equipments.

The cost of the fiber connectivity has been calculated by applying the BIPT direct CAPEX unit to the number of VDSL2 subscriptions. It includes trenching and fibre cables cost.

3.4.2.6.6.6.2 *Active part*

The asset AC2_20107 NGA Active equipment has been valued based on the related BIPT direct CAPEX cost.

It is mainly related to the IP DSLAM installed in the ROP or in the local site, the equipment to aggregate the fibre cables connecting the ROP to the local exchange (“aggregators”), as well as internal cabling and block positions on the optical main distribution frame (OMDF).

3.4.2.6.6.7 WBA transport

WBA transport regulates the transport of Ethernet based data (unicast VLANs), covering the complete Belgacom Ethernet/MPLS network, with the exception of the highest hierarchy level, the Intercity network or express layer. The current BIPT decision on this pricing dates from 6/8/2010.

The Ethernet data, grouped in VLANs, is directly carried on densely multiplexed optical wavelengths over optical fiber. Thus, the technologies to be valued via this model are:

- Ethernet (AC2_20105 ethernet equipment): values the ethernet routers and switches allowing the transport of Ethernet data within an ethernet area.
- DWDM (AC2_20101 (D)WDM equipment): covers the cost of the Dense Wavelength Division Multiplex network that, together with the fibre infrastructure, brings the physical connectivity amongst the Ethernet equipments.
- Optical fiber infrastructure (AC2_20106 fibre infrastructure): as referred in bullet above.

In order to obtain the value of each of the above technological components, the direct CAPEX unit costs for the different technologies have been applied to the unicast VLANs implemented on the MPLS network. The VLANs have been estimated, in number and required bandwidth, based on the inventory of customers and DSLAMs per local exchange and the associated usage to the user's profile.

3.4.2.6.6.8 BROTSOLL Ethernet

Being a special case of BROTSOLL, the services within the BROTSOLL Ethernet scope are the dedicated transparent Ethernet connections. The current BIPT decision on this tariff dates from 10/3/2008.

In principle these lines are implemented as Ethernet over SDH. However, due to the rather large bandwidth typical to this type of services -10 Mbps, 100 Mbps or 1Gbps- this implementation is neither always possible nor efficient. Therefore we distinguish two main technical executions:

- Ethernet over SDH: for the 10 or 100 Mbps lines, also named Ethernet and Fast Ethernet respectively
- Ethernet over DWDM: for the 1 Gbps or Gigabit Ethernet lines, where the DWDM wavelength is dedicated to the line. Note that no SDH equipment is used in this case.

Due to the lack of a BIPT model backing up the regulated tariffs, Belgacom has developed two simple models in order to arrive to valid cost oriented tariffs for asset valuation purposes (see the below sub-paragraphs for further details on the development of these models). These tariffs contribute to the valuation of the following assets, as these technologies are found in the implemented technical solution:

- Ethernet over SDH (10 or 100 Mbps):
 - SDH
 - Optical fiber infrastructure
- Ethernet over DWDM (1 Gbps)
 - DWDM
 - Optical fiber infrastructure

The valuation has been done by applying the appropriate above technologies direct CAPEX unit cost to all the links implemented over SDH under the BROTSoLL Ethernet scope which are documented in ITR, the Belgacom transmission inventory system.

3.4.2.6.6.8.1 BROTSoLL Ethernet model for 10 or 100 Mbps lines

Transport tariff component

Since the 10 or 100 Mbps BROTSoLL Ethernet lines are typical BROTSoLL lines, except for their larger and non Synchronous Digital Hierarchy compliant bandwidth, the model used in this case is just the original BROTSoLL model which has only been fed with the 10 or 100 Mbps lines existing on the Belgacom network at the end of 2010. Provided that the 10 Mbps lines are treated as a set of 5 E1 and the 100 Mbps lines as 1 STM-1, this model delivers the monthly transport costs for such a network.

Nevertheless, there is a fundamental difference between the BROTSoLL and the BROTSoll Ethernet tariff structures, being that the first one is network topology oriented (local, intraZonal, intraArea) while the last one is distance oriented. The difference has been overcome by considering the links distance information available in the model to proportionally distribute the distance dependent costs to the length of the links.

The SDH costs are considered as not distance dependent, so that the SDH costs per bandwidth type have been distributed over all the links with the given bandwidth. On the other hand, the optical fiber infrastructure cost is proportional to the distance and therefore these types of costs, per bandwidth type, have been distributed, proportionally to the actual length of the links, over the different distance ranges introduced in the BIPT BROTSoLL Ethernet tariff.

Access tariff component

The access tariffs are the same as in BROTSoLL.

3.4.2.6.6.8.2 BROTSoLL Ethernet model for 1 Gbps lines

Transport tariff component

Given the fact that the lines subject to be valued by this model are dedicated DWDM wavelengths to the BROTSoLL Ethernet line, the average tariff is constituted by:

- the actual cost of a kilometer of DWDM wavelength according to the Belgacom Regulatory Cost Model 2009.
- the cost of a Km optical fiber infrastructure, according to BROTSoLL.

Finally, this average cost per kilometer of wavelength has been annualized and de-averaged to obtain a tariff per distance ranges as that of the regulated tariff.

Access tariff component

The access tariffs are the same as in BROTSoLL.

3.4.2.6.7 Non regulated tariffs as base for asset valuation

3.4.2.6.7.1 Adapted unicast price model for multicast

The only multicast service currently carried by the Belgacom's network is BroadcastTV. Since the VLAN used by this service is shared by all the Belgacom TV customers, the VoD shared VLAN tariff could initially be contemplated as tariff.

However, the maximum bandwidth this VLAN can reach is reserved for multicast services, while the bandwidth of the unicast VLANs –within the WBA transport scope- cannot be reserved. Hence, the unicast VLAN tariff is not applicable anymore.

This bandwidth reservation characteristic needs to be valued, for it represents a disadvantage, a reduction of the overall available bandwidth, for the unicast VLANs coexisting in the same physical medium. Since the reserved bandwidth for multicast is one fifth of the physical medium bandwidth (maximum 2 Gbps multicast traffic over the 10 Gbps bandwidth of the DWDM bandwidth), the multicast tariff used for valuation purposes is five times that of the unicast.

As this model is an adaptation of the WBA transport model, it contributes to the same assets as the WBA transport:

- Ethernet
- DWDM
- Optical fiber infrastructure

The valuation of the assets consumed by this service is calculated by applying the direct CAPEX tariff components to all the configured multicast VLANs in the network.

3.4.2.6.7.2 Local Tail Explore

Local Tail Explore refers to the access line, this is to say the set of equipments and infrastructure entailed to provide the connectivity between the customer and the Belgacom network, the Explore customers require. Given that Explore is not a regulated product and has specific technical requirements that are not contemplated by any of the existing BIPT models, a new model needed to be developed to cost this segment.

In fact the model is very straightforward since it just consists of isolating the few different components in the offered technical solutions and applying their respective annualized costs. Since the infrastructure components present in this model have already been valued by existing BIPT models, the regulated direct CAPEX unit costs have been applied to them.

The assets in which this model participates are:

- Ethernet
- Optical fiber infrastructure

In principle, this model should also contribute to the Copper infrastructure, since there is a technical solution on copper, however this asset valuation component is fully taken into consideration by the valuation based on the BRUO model.

The valuation has been done by applying the fitting direct CAPEX technology to all access lines to Explore services documented in ITR, the Belgacom transmission inventory system.

3.4.2.6.7.3 Incremental intercity model

This model is an incremental inventory based model that covers the cost of the equipment and infrastructure deploying the express layer of the network.

It is incremental since only the extra costs incurred in the implementation of such intercity network are taken into account.

Further, for it is an inventory based model, inventories for all the technologies present at the intercity level, namely fiber infrastructure, DWDM, SDH and Ethernet, were gathered.

Then the corresponding gross replacement costs have been applied and annualized arriving to the total gross replacement costs per technology of the intercity network.

3.4.2.6.8 ATM equipment asset valuation

The valuation of the ATM asset has been aligned with the BIPT BROBA model.

In the ATM network architecture two levels of ATM switches are present: the local ATM switch, and the area level ATM switch, the area level nodes correspond to the interconnect areas used in BRIO, BROBA and BROTSOLL. The function of the ATM network is to provide switched Virtual Paths between a port of a local switch and another port of the same local switch (local VPs) or of an area switch (nonlocal VPs). For Virtual Path switching two equipments are involved: the ATM switches themselves (also called switching fabric), and the trunk interfaces to interconnect distant ATM switches. In order to access configured Virtual Paths, access interface equipments are needed at the border of the local or area switches.

The ATM asset contains the investment costs of the equipments delivering switched Virtual Paths (the ATM local switches, the ATM area switches, the ATM trunk interfaces for the backhaul links between the ATM switches) and the equipment delivering access to VPs (ATM interfaces for the ATM tributaries or clients).

The costing of the asset is thus decomposed in the costing of the VP switching equipment (backbone ATM equipment) and in the costing of the access to VP equipment.

3.4.2.6.8.1 CAPEX Costing of the VP switching component

This costing is based on the inventory of switched Virtual paths (local VPs, and non-local VPs) configured on the Belgacom ATM network. Each virtual path is valued using the BIPT BROBA VP tariffs. Indeed, the BIPT tariffs are cost based and are established using a bottom-up costing model.

However, the BIPT tariffs being full cost tariffs, they integrate the ATM CAPEX, the ATM OPEX, the backhaul transmission costs (links between the ATM trunks interfaces), the IT costs and the overhead costs. Applying directly the BIPT BROBA tariffs would incorporate costs other than ATM CAPEX costs in the ATM asset. Therefore the costing is conducted in 3 steps:

The first step eliminates the IT, the overhead and the backhaul costs component from the BIPT tariff computing a tariff structure free of IT/overhead/backhaul. The second step applies this tariff to the inventory of VPs yielding a ATM cost containing ATM CAPEX and ATM OPEX. The third step calculates the OPEX costs corresponding to the network equipment amounts allowing the VPs of the inventory and subtracts this cost from the ATM CAPEX&OPEX. The end result is an estimation of the pure CAPEX cost for all configured VPs.

There are many advantages in using this approach; first, the BIPT BROBA tariffs per VP value complex VP characteristics like Quality of Service, Peak Cell Rate / Sustained Cell Rate ratio, distance aspect (local, nonlocal VPs) and VP capacity. Secondly, the BIPT tariffs also value other material costs directly involved in ATM like cabling investment costs and ATM management platform investment costs.

3.4.2.6.8.1.1 Elimination of IT, Overhead and backhaul components in BIPT tariffs

We used the Bottom-Up tariff calculation model of the BIPT where the IT, overhead and backhaul transmission components are easily identified and isolated. The IT and overhead are calculated via markup percentages (resp. 6% and 7%). These are easily eliminated from the Tariffs.

Further , the BIPT tariff parameters are the parameters of 4 linear regressions on 4 data sets (see “Besluit van de Raad van het BIPT van 22 oktober 2008 met betrekking tot de BROBA rental fee” pages 31-to-36):

- a calculated data series of total VP costs versus growing bandwidth for local VP with bandwidth $\leq 1\text{Mbs}$
- a calculated data series of total VP costs versus growing bandwidth for nonlocal VP with bandwidth $\leq 1\text{Mbs}$
- a calculated data series of total VP costs versus growing bandwidth for local VP with bandwidth $> 1\text{Mbs}$
- a calculated data series of total VP costs versus growing bandwidth for nonlocal VP with bandwidth $> 1\text{Mbs}$

We used the BIPT bottom-up model to derive VP backhaul costs for the same series of bandwidths and subtracted them from the total VP costs in order to produce the same 4 data sets as in the BIPT model but without IT , overhead and backhaul costs . The linear regression parameters on these data sets provide the cost price parameters for VP costs without IT, overhead and backhaul costs. The next exhibits compare the 4 BIPT cost data sets presented in the BIPT pricing decision document (“Besluit van de Raad van het BIPT van 22 oktober 2008 met betrekking tot de BROBA rental fee”), with the data sets free of IT, overhead and backhaul costs.

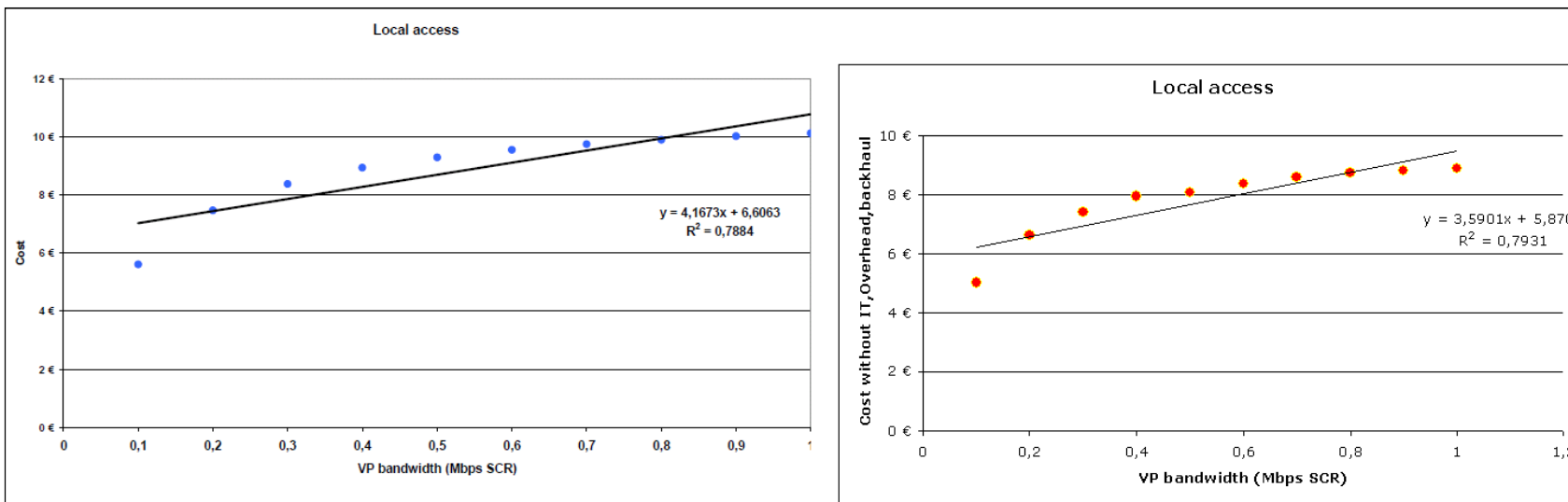

Figure 6 - Small bandwidth

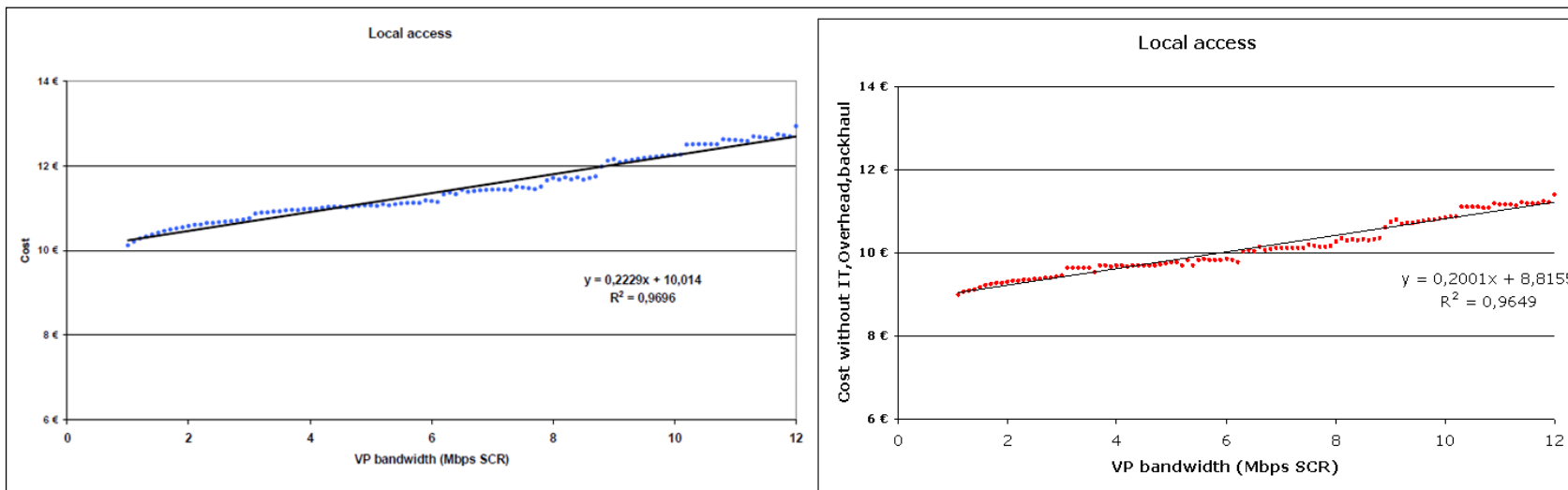

Figure 7 - Large bandwidth

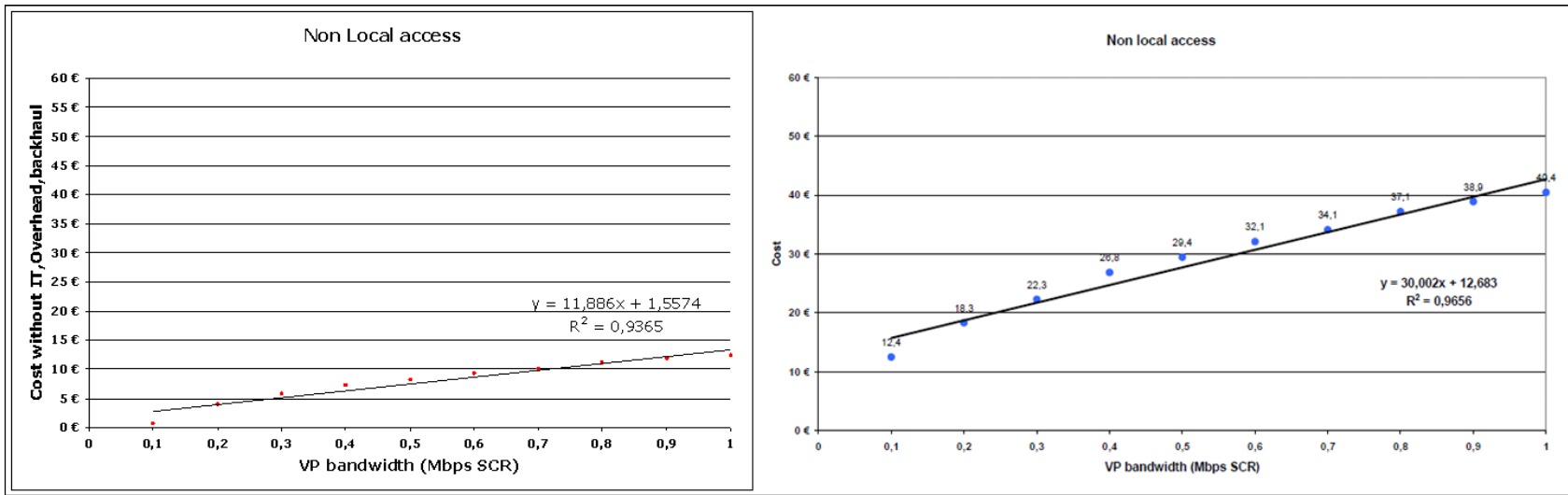

Figure 8 - Small bandwidth

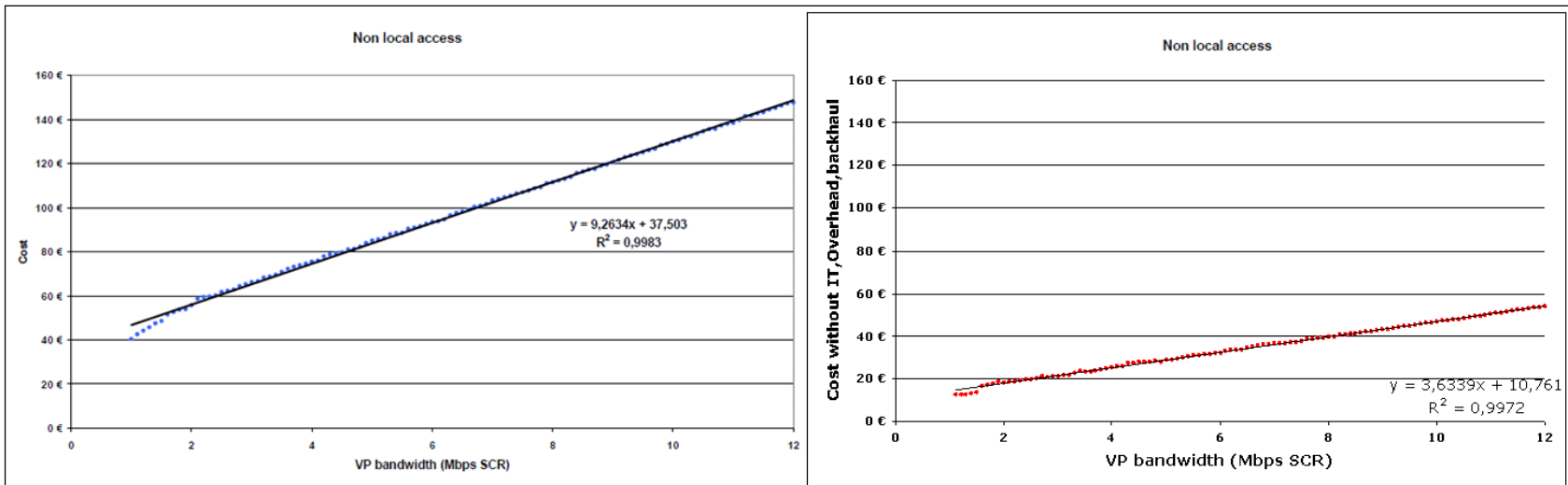
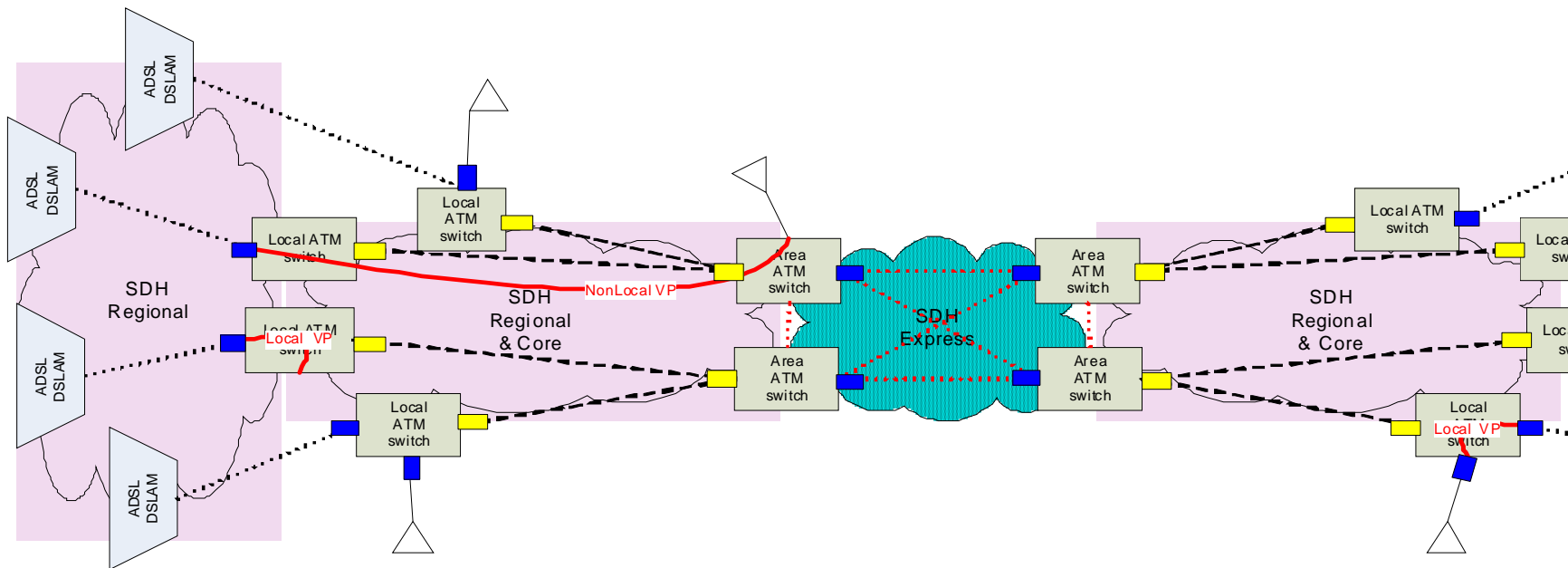

Figure 9 - Large bandwidth



Legend:

- DSLAM-ATM Backhaul links
- ATM-ATM Regional&Core Backhaul links
- ATM-ATM Express Backhaul links
- Access to ATM network
- NonLocal VP ATM Regional Virtual Path non local
- Local VP ATM Regional Virtual Path local
- ATM trunk interfaces (for links between regional ATM switches)

Figure 10 - ATM network

3.4.2.6.8.1.2 Calculation of ATM costs (CAPEX & OPEX)

The tariffs determined in previous step are free of IT, overhead and backhaul costs , in other words they correspond to the ATM CAPEX and OPEX costs . These tariffs are simply applied on the inventory of VPs configured on the Belgacom network yielding a total ATM CAPEX + OPEX cost.

3.4.2.6.8.1.3 Elimination of ATM OPEX costs

In the BIPT bottom-up model, the ATM OPEX costs depend on the amount of equipment deployed in the network, which itself depends on the network load (expressed as a load factor). Belgacom has estimated the network load factor of the BIPT model that best corresponds to the estimated traffic switched in all the VPs of Belgacom ATM network.

Afterwards, the ATM OPEX costs are calculated in the BIPT bottom-up model using that load factor.

The total ATM OPEX costs are subtracted from the total ATM CAPEX +OPEX costs determined in section 3.4.2.6.8.1.2, resulting in the ATM CAPEX cost. This final value is the yearly CAPEX costing of the VP switching component of the ATM asset.

3.4.2.6.8.2 CAPEX Costing of the ATM access component

The CAPEX costing of the ATM access component is based on the detailed inventory of access lines ending-up in ATM switches; the source of this inventory is the ITR infrastructure inventory system. Only the tributary lines are considered in this inventory as the accesses for ATM inter-switch links (trunks) are already valued in the VP switching component.

The same unit costs of ATM ports as in the BIPT Bottom-Up BROBA model are applied on this inventory depending on the capacity of tributary lines to come to the CAPEX costs of the ATM access component.

3.4.3 TAM: Tilted Annuity Method

3.4.3.1 Theory

The purpose of this section is to describe how the Tilted Annuity Method (TAM) is finally implemented in the Current Cost Accounting (CCA) based network cost model 2010.

As from the 2003 model, Belgacom implemented the formula that BIPT suggested.

$$ACC_{\mu Y} = F1, \mu Y \times F2, \mu Y$$

where

$$F1, \mu Y = (GRC_{\mu Y, \text{begin}} + GRC_{\mu Y, \text{end}}) / 2$$

$$F2, \mu Y = \sqrt{(1 + WACCY) \times [1 - (1 + APC_{\mu}) / (1 + WACCY)]} / [1 - [(1 + APC_{\mu}) / (1 + WACCY)]^{L_{\mu}}]$$

and where

- $ACC_{\mu Y}$: Annual CAPEX Cost of asset μ and year Y . It includes the annual depreciation and the cost of capital.
- $WACC_Y$: WACC of year Y .
- $GRC_{\mu Y, \text{begin}}$: Gross Replacement Cost of asset μ at the beginning of year Y .
- $GRC_{\mu Y, \text{end}}$: Gross Replacement Cost of asset μ at the end of year Y .
- APC_{μ} : Annual Price Change of asset μ .
- L_{μ} : Lifetime of asset μ .

Remarks:

The formula assumes that:

- In the beginning of year Y was invested in an asset and that at the middle of each year of the lifetime of the asset revenues will be generated.
- The annual price change is constant over the lifetime of the asset.
- The asset price does not evolve during the year, i.e. price changes only appear at January 1st.

The factor $F_{1, \mu Y}$ represents the value of asset μ in the middle of year Y .

- The purpose of the arithmetic average of $GRC_{\mu Y, \text{begin}}$ and $GRC_{\mu Y, \text{end}}$ is to take into account investments or disinvestments of asset μ during the year Y .
- The arithmetic average of $GRC_{\mu Y, \text{begin}}$ and $GRC_{\mu Y, \text{end}}$ does not filter out the price evolution of the asset μ during the year Y .

The difference between the formula of BIPT and the formula of Exhibit 5, p. B3. of the white paper of Analysys is the factor $1 / \sqrt{1 + APC_{\mu}}$, which filters out the price evolution of the asset μ during the year Y .

The gross replacement cost (GRC) of assets at any particular point in time is calculated as the sum over all assets owned by the business at that point in time, of the investment that would be necessary to purchase and install new replacements for those assets at that point in time (using modern equivalent assets if the existing assets are no longer available or efficient). The replacement value of assets, used for costing purposes should always include the gross value of every asset in use by the business (the current cost of replacing it with a new, possibly modern equivalent asset), irrespective of the history of depreciation of that asset in any financial accounts to date.

L_{μ} : Lifetime of asset μ , i.e. the expected useful lifetime of the new asset μ .

The depreciation period and the expected useful lifetime of a new asset are defined differently. The depreciation period refers to accounting. The expected useful lifetime of a new asset does not refer to accounting. It refers to the period that is expected that a new asset will be used. The main factor to determine the expected useful lifetime of a new asset is the evolution of the associated operational costs, i.e. the asset will be replaced when operating it becomes too expensive. Another

factor is the appearance of new technology: if in the future new technology will come-up it could be that the asset will be replaced (even if it is not too expensive to operate).

Important remark :

This formula is applied for all network assets except for some assets related to radio access network . For these assets however, the assumption of a constant price trend over the lifetime period is inadequate because important negotiations for replacement of these assets and started during 2009 announce sharp and different price changes over short periods during the asset lifetime . In this case , the economic depreciation series must be computed step by step because it cannot be expressed analytically in a formula like the previous one.

4 SRW stream

4.1 Allocation of the support costs

Compared to the 2009 cost model we have two major changes in the support costs allocation :

- All support costs are treated within one SUPPORT module.
- We use no more a cascade principle meaning that support costs, once in the SUPPORT module, can only be allocated to a non support destination and to a non support division.

The consequence is that some support pools used last year disappeared. This is e.g. the case for Manage, maintain and repair Buildings BDC warehouse space, Telecom space, parking space, cable warehouse and catering space. These costs are respectively allocated to manage goods, warehouse & equivalents, support telecom space SDE, manage maintain and repair fleet vehicles (management, sales, utility cars), manage cables and provide catering services.

As we are no more working with primary activities for commercial retail costs, we have some new support costs like for CBU, EBU, CWS and MOB Billing activities. We also have new specific support activities for Mobile e.g. Support_PROX_Pylons.

A summary of the support activities and their drivers is provided in the following table:

Support activity	Driver
CBU_billing	Billing & credit risk info
CBU_billing_fix products	number of clicks/stuffing
CWS_billing	number of clicks/stuffing
EBU_Billing	Billing & credit risk info
EBU_billing_fix products	number of clicks/stuffing
Industrial Clothing	
MOB_billing	number of clicks/stuffing
Support_Internal mail services	FTE office
Support_IT	sent to IT Constellation
Support_Manage cables	
Support_Manage goods, warehouse & equivalents	nbr of picking lines
Support_Manage internal distribution	transported volumes (% cubage)
Support_Manage moves	Nbr of moves
Support_Manage waste and scrap	FTE office
Support_Manage, maintain and repair buildings (excluding moves) (office space)	FTE office
Support_Manage, maintain and repair buildings (excluding moves) (shop space DIR)	TTVA (total transaction value of new contrats)
Support_Manage, maintain and repair buildings (excluding moves) (shop space IND)	TTVA (total transaction value of new contrats)
Support_Manage, maintain and repair fleet vehicles (management vehicles)	nbr management cars
Support_Manage, maintain and repair fleet vehicles (sales vehicles)	nbr sales cars
Support_Manage, maintain and repair fleet vehicles (utility vehicles)	nbr utility vehicles
SUPPORT_MOB	nbr warehouse sqm or direct if MOB CCG
Support_Power Chain for telecom_SDE	
Support_Process suppliers' invoices	APC invoice lines
Support_Provide catering services	FTE office
Support_Provide copy services	total price of copy services (copyshop costs)
Support_Provide printing services (excluding outgoing invoices)	CBU revenues
Support_PROX_Pylons	direct
Support_Purchasing, quality and ordering	PO Amount
Support_Reverse logistics	nbr entry lines RSC
Support_Telecom space_SDE	

4.2 Allocation of Retail costs

4.2.1 Determination of the retail cost perimeter

As stated previously the Belgacom organisational structure distinguishes between 4 distinct pillars called Business units, we recapitulate :

- Consumer Business Unit (CBU) has the responsibility over the residential customers
- Enterprise Business Unit (EBU) has the responsibility over the professional customers
- Service Delivery Engine (SDE) centralises network and IT services
- Staff and support (S&S) groups all horizontal functions sustaining the Group activities

All commercial retail activities are situated at the level of Business unit CBU (consumer business unit) for the residential customers and at the level of Business unit EBU (enterprise business unit) for the professional customers.

The Belgacom financial and accounting structure clearly registers (directly attributable) retail costs on costcenters 39xxxx (retail for residential customers) or costcenter 41xxxx (retail for professional customers).

However, a number of costs are not directly attributed to retail in the accounting books.

It concerns :

1. Costs which are centrally booked and/or managed but which need to be flagged towards all Belgacom personnel/FTE's (and thus also towards these residing under CBU and EBU). F.e. cost re. Fleet, office building, traincards, bonus, training, gsm's in the context of the employee phone program, ...
2. Non FTE related costs which are centrally booked and managed but relate to retail activities F.e. Billing, Shop space, ...

The costs under point 1. above are added up with the directly attributable FTE related cost assembled in module CCG_HMC (the human manpower cost in a large sense –payroll costs and personnel related Services & Other Goods costs- per cost center grouping) and allocated towards the organisational groups (among which the retail organisational groups CCG_CCA for call center activities; 39xxx and 41xxx) in module “Organisational group”.

The costs under point 2. above are identified as specific objects in Module Support and are further allocated towards products in the Retail allocation procedure.

As a result of the above allocation flow, we can thus identify 4 blocks of retail costs :

1. Organisational group costs of organisational groups 39xxx, 41xxx and CCG_CCA (CCG_CCA is the grouping of CCG's for call center activities).
2. Retail (non FTE related) support costs.
3. Directly to retail attributable costs based on Costpool-cost center group combinations (CP-CCG) which are not directly attributable towards ABC_products.

4. Directly to ABC_PRODUCTS attributable costs based on Costpool-cost center group (CP-CCG) combinations which are not processed through steps 1. and 3.

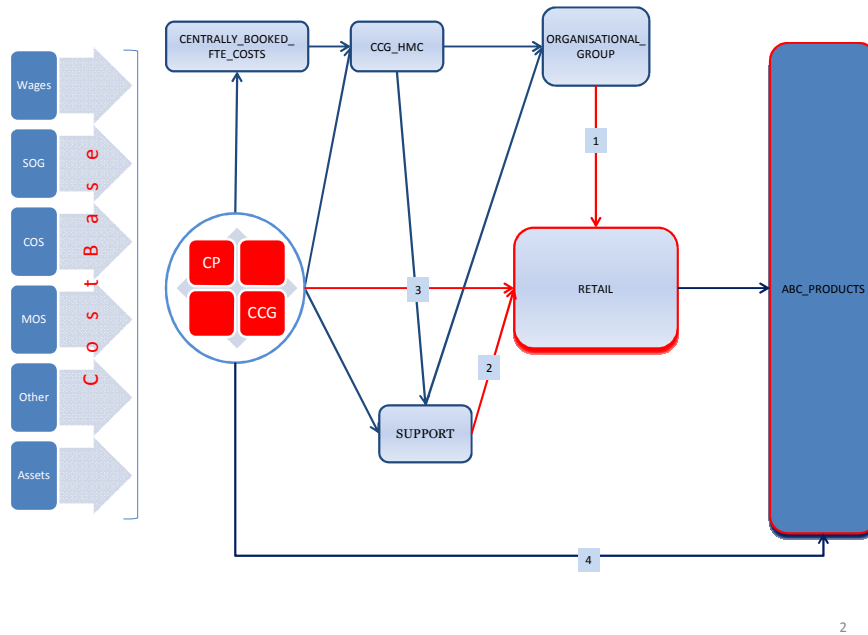

Figure 1 : functional flow identification of retail costs

4.2.2 Introduction of 2 cost type dimensions

Two cost type dimensions are introduced in the cost model specifically at the level of retail costs.

These dimensions are “VAR_TYPE” and “PS_TYPE”.

4.2.2.1 Dimension VAR_TYPE

Dimension VAR_TYPE qualifies retail costs based on their variability towards product volumes.

We distinguish between 4 var_types :

- a. Marginal (mar) : retail costs which can be considered variable with 1 additional unit of output. Typically it concerns costs of goods sold (f.e. handsets, customer premises equipment, ...) and costs of sales (commissions, interconnection costs,...).
- b. Variable (var) : retail costs which can be considered productvolume sensitive on the long run. In this context, we assume Belgacom and its organisational structure as an ongoing concern within a timeframe of 3 years. F.e. a part of the sales force could be considered as variable on the long run in case of a material volumechange of a specific product. This reflects (limited) flexibility of the economical and social environment.

- c. Fix (fix) : retail costs are considered as fixed when they are likely to be inert to important volume variances within a timeframe of 3 years (Belgacom ongoing concern assumption). F.e. Belgacoms Marketing budget is rather constant over time. Indeed, the allocation towards specific products alters over time, but the absolute amount of this budget is rather linked to the size and market position of the enterprise than to specific products.
- d. Common (common) : retail costs are considered to be common when they do not reside under the forementioned. In general, it concerns costs for litigations, sponsoring, ...

4.2.2.2 Dimension PS_TYPE

Dimension PS_TYPE qualifies retail costs based on whether they can be attributed directly or through a specific non generic and/or non general drivers towards the specific products.

Thus , we distinguish between 2 PS_types :

- a. PRODUCT_SPECIFIC : these costs can either be allocated directly to the products or through a specific non generic, non general driver (f.e. SOG cost of advertising campaigns based on specific expenses on products for advertising campaigns).

The identification of the qualification “product_specific” towards products is done at the level of the CP-CCG combinations.

For organisational group costs this identification is done at the level of the module ‘retail’ (dedicated teams).

- b. NON_PRODUCT_SPECIFIC : Retail costs which do not have a clear link with specific products.

The identification of the qualification “non_product_specific” is done at the level of the CP-CCG combinations.

For organisational group costs this identification is done at the level of the module ‘retail’.

Non_product_specific costs are allocated towards the ABC_products based on a generic or general driver (f.e. non dedicated sales departments, teleshops, sponsoring & events, ...) in the module “retail”.

4.2.3 Determination of var_type qualifications

4.2.3.1 Var-fix determination of retail organisational groups

The retail organisational group objects contain all organisational group expenses per cost center grouping of the retail departments.

One exception however : specifically for the Call Center activities the CCA CCG's are restated towards the functional and reporting organisation as maintained by CCA management in order to facilitate fix-var determination.

As a general principle from a structural point of view we consider Belgacom as ongoing concern within a timeframe of 3 years.

This implies that a minimum occupation of the organisational structure has to be assured.

As the organisational structure is translated in the cost center structure of Belgacom, we consider a minimum occupation per cost center of 1 FTE as fixed for product and customer sensitive cost center groups, in casu sales and call center activity costcenter groups.

Retail support departments (determined based on functional description of the cost center) are considered fixed.

Based upon above criteria the split between fix and variable FTE's has been set (in module retail) :

4.2.4 Product allocation of NON_PRODUCT_SPECIFIC retail costs

In module Retail the non_product_specific costs are grouped in cost groups identifying the span of products to which they relate.

The different cost groups identified are the following :

- ALL RETAIL PRODUCTS
- ALL FIX LINE PRODUCTS
- ALL MOBILE LINE PRODUCTS
- ALL CBU RETAIL PRODUCTS
- ALL CBU FIX LINE PRODUCTS
- ALL CBU MOBILE LINE PRODUCTS
- ALL EBU RETAIL PRODUCTS
- ALL EBU FIX LINE PRODUCTS
- ALL EBU MOBILE LINE PRODUCTS
- CP_61780

The combination costgroup-organisational unit-var_type determines the drivers towards the products.

- Fix costs on CBU Sales & customer care organisational units are allocated based on TTVA per channel (total transaction value of new contracts).
- Variable costs on CBU Sales departments & customer care organisational units are allocated based on TTVA volumes.
- Fix and common costs on all other organisational units (non CBU sales and non customer care) are allocated based on revenue.
- Variable costs on EBU organisational units are allocated based on provisioning volumes.

4.3 Allocation of CWS (Customer Whole Sale Division) related costs

CWS Flow Description

The allocation flow is a standard flow :

The Cost base is allocated to products via different cost objects :

- Activities (mainly for wages) and then to products,
- directly (mainly for COGS),
- or through “generic” key (HMC costs or Overhead-like costs).

Material out of stocks:

The MOS is composed by HMC related items (GSM...), CPE and ICT. CPE items are allocated to “26001 Other Wholesale”. Items related to ICT are allocated to “23001 Data Managed Services & Applications”.

Other operating charges :

The costs are mainly related to ARBOR which is a Mobile related Billing system.

Remuneration allocation:

The costs are allocated to Activities through the usage of a classic activity grid. This is centrally filled in.

Here below the CWS activities:

TO_DESCR_ACTIVITY	DRIVER	Total
1.2.1. Acquire, retain & stimulate customers (marketing)	FTE	21,7
11.1.1.1. Provide operational excellence	FTE	8,4
2.3.3. Develop & sell proposals for standard products or integrated solutions (including client visits)	FTE	19,9
2.3.5. Negotiate and establish BRIO/BRUO/BROBA/BROTSOLL agreements with operators / service providers	FTE	5,2
2.4.1. Handle customer orders	FTE	12,9
2.8.4. Manage projects related to the provisioning of telecom & IT solutions - Prof	FTE	9,6
3.2.1. Receive and handle customer inquiries or complaints not related to billing	FTE	24,9
3.2.2. Provide Customer Service/SLA management - Prof	FTE	8,2
4.1.1. Receive and handle billing inquiries & complaints	FTE	4,5
4.2.5. Manage and control billing related operations & financial flows	FTE	2,8
4.3.3. Manage debit collection	FTE	3,0
4.4.1. Manage SAP A/R related manual bills / credit notes	FTE	1,5
4.5.1. Manage IBIS-related national inter-carrier billing problem handling, production & collection	FTE	2,0
		124,5

The allocation of these activities to products is described here below :

ACTIVITY	DRIVER
1.2.1. Acquire, retain & stimulate customers (marketing)	FTE per product // Rev per product
1.1.1. Provide operational excellence	Billed revenues per system
2.3.3. Develop & sell proposals for standard products or integrated solutions (including client visits)	Bonus pay-out
2.3.5. Negotiate and establish BRIO/BRUO/BROBA/BROTSOLL agreements with operators / service providers	Bonus pay-out
2.4.1. Handle customer orders	# actions
2.8.4. Manage projects related to the provisioning of telecom & IT solutions - Prof	# actions
3.2.1. Receive and handle customer inquiries or complaints not related to billing	# actions
3.2.2. Provide Customer Service/SLA management - Prof	# actions
4.1.1. Receive and handle billing inquiries & complaints	Billed revenues per system
4.2.5. Manage and control billing related operations & financial flows	Billed revenues per system
4.3.3. Manage debit collection	Billed revenues per system
4.4.1. Manage SAP A/R related manual bills / credit notes	Billed revenues per system
4.5.1. Manage IBIS-related national inter-carrier billing problem handling, production & collection	Billed revenues per system

Services and other Goods :

Personnel related costs are allocated to CCG_HMC. Non personnel related SOG are allocated to Product/activities through logic allocation keys (e.g. Consultancy, via consultants workload ...) or directly to a product or an activity (i.e. events related costs are allocated to “ 1.2.1. Acquire, retain & stimulate customers (marketing)”).

COGS related SOG :

They are directly allocated to products using as driver “percent - CWS Direct margin Cube”.

5 Network&IT OPEX de-aggregation

5.1 Common OPEX allocation stream IT and Network

In the current organisation, there are no distinct ranges for IT cost centers and Network cost centers. Thus, a same cost center may register IT costs together with non IT costs.

The first goal of the allocation stream is to separate all costs into IT specific costs and Network specific costs.

5.1.1 GL61 accounts – Services and Other Goods (SOG)

The GL accounts in the 61 range mainly register outsourcing, consultancy, renting & maintenance costs as well as miscellaneous costs driven by staff (GSM, memberships, office material, internal events etc.).

The GL61 accounts were classified in two categories:

- those that may contain some manpower related consumption goods
- those that clearly do not contain manpower related consumption goods

In both cases, an attribution to cost objects is always done at SAP record level. This attribution takes place using different criteria:

- attribution based on GL account denomination (e.g. all records of “61302000 Telecommunications – Mobile – Use GSM & GPRS” are attributed to the FLAG object “CP_SOGFTE_cc” where cc is the cost center of the SAP record)
- attribution based on SAP details: this is for example the case for “GL 61130400 Maintenance – Infrastructure – Local/nat network” ; drilling down into SAP records allows to separate IT maintenance and network equipment maintenance.

A variety of destination objects receive costs from GL61 accounts: IT cost objects, Network cost objects, HR driven cost objects and ABC products.

For most categories of GL61 accounts, the attribution is reported at the level of CostCenter/GL account, except for some categories where the attribution is reported at GL account level. This is why in this last case, the GL61 costs are grouped in IT&NW_SOG_POOLS aggregating the cost centers.

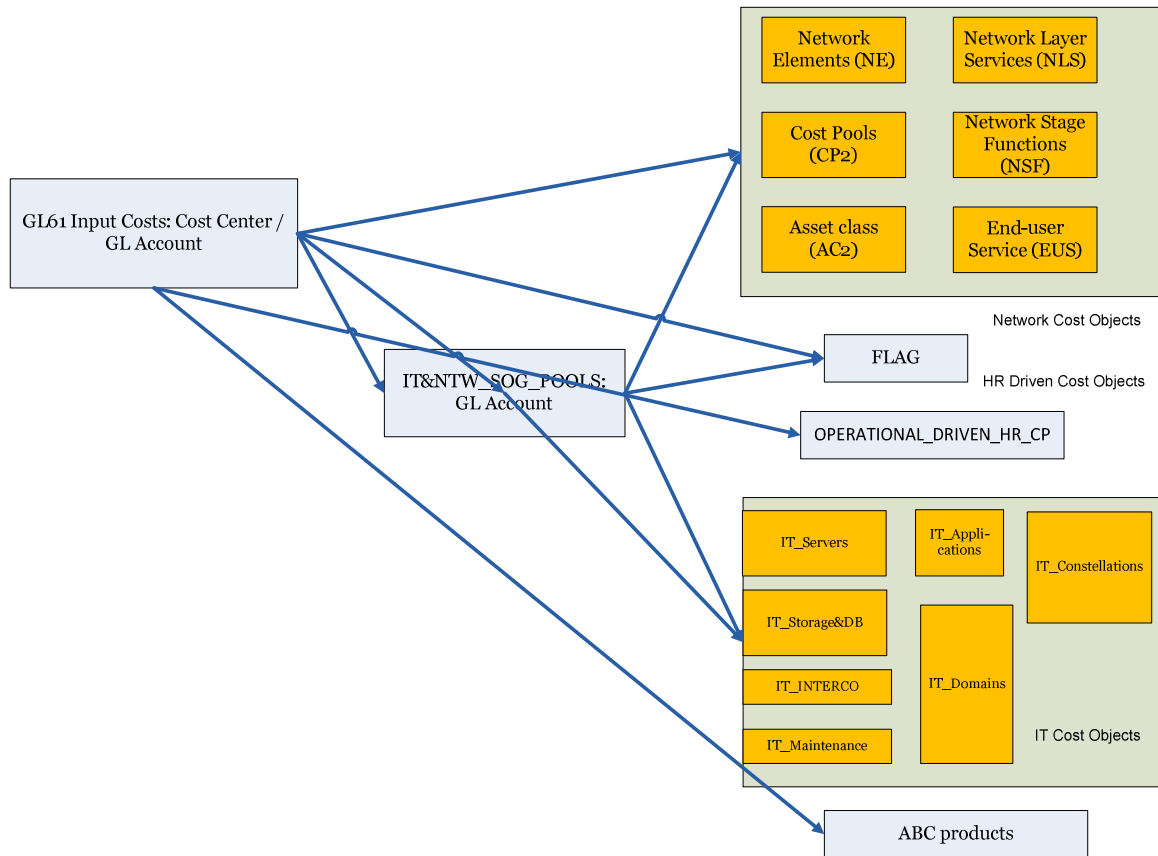

Figure 11

5.1.2 GL62 accounts – Wages costs

The GL accounts in the 62 range register remuneration costs of salaried staff and manual workers, premiums, social security, bonus etc. Again, these costs are registered per cost center thereby mixing IT staff and non IT staff. The allocation process of OPEX wages cost is processed through a cascade.

Step 1-

The allocation stream of wages costs first aggregates the input data into two categories of cost pools (very similar to cost pooling in the SRW model but at the level of cost center instead of cost center group):

- 1) a remuneration cost pool “SDE_CC_HMC” composed of:
 - 6201 level 1
 - 6202 level 2B
 - 6203 level 2A
 - 6204 level 3&4
 - 6205 level S
 - 6206 All levels

- 6291 Transfert of TGR cost
- 6207 Level Other
- 6210 PROX_TLD_costs
- 6299 All remuneration costs

2) a corrective remuneration cost pool “SDE_CC_WAGES_PFA” composed of :

6213 - Correction personnelcost

Step2 –

The corrective cost pool is allocated as follows :

Cost pool	Destination	Allocation driver
CostCenter x / 6213 Correction personnelcost	TGx	# FTE TGx/# FTE CCx

Step3 –

The remuneration costs are split over the SDE teamgroups based on the number of FTE in each teamgroup. Indeed, to allow the separation of IT and nonIT remuneration costs, we need to drill down to the level of teams.

74 teamgroups have been defined as management or productive_overhead teams (dedicated to management or overhead tasks) and 199 teamgroups as executive teams.

Management and executive teams must be separated since the cost drivers are different:

- management team costs are related to the span of control in a structured organisation which is reflected by the number of managed teams and the headcount within these teams,
- productive_overhead team costs are related to the span of support,
- executive team costs are related to the Network or IT tasks.

The following drawing shows the management hierarchy considered in the model to measure the span of control of the management teams for SDE (for illustration purposes).

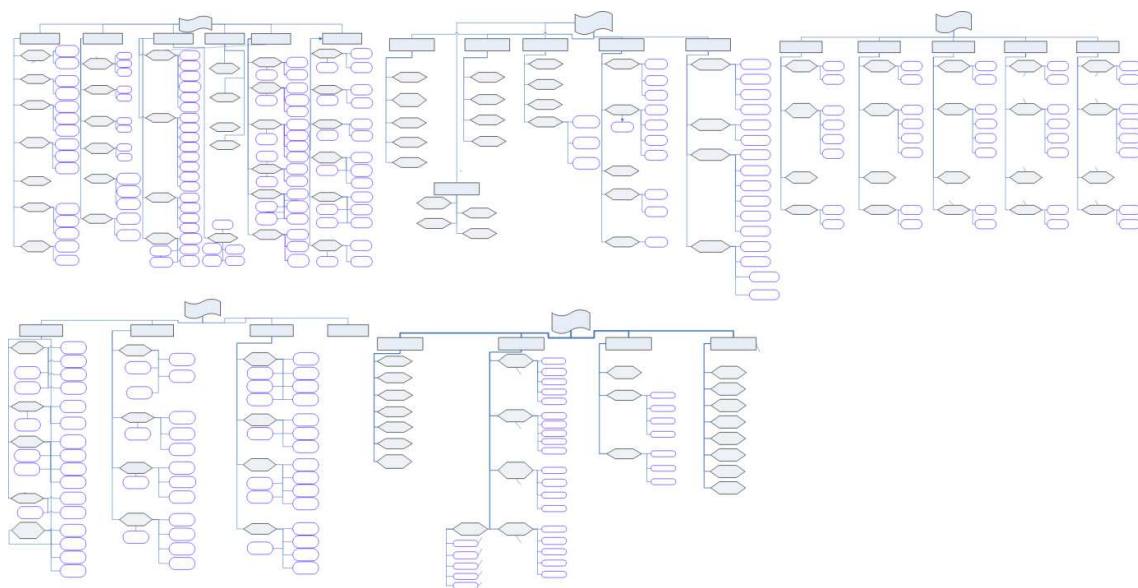
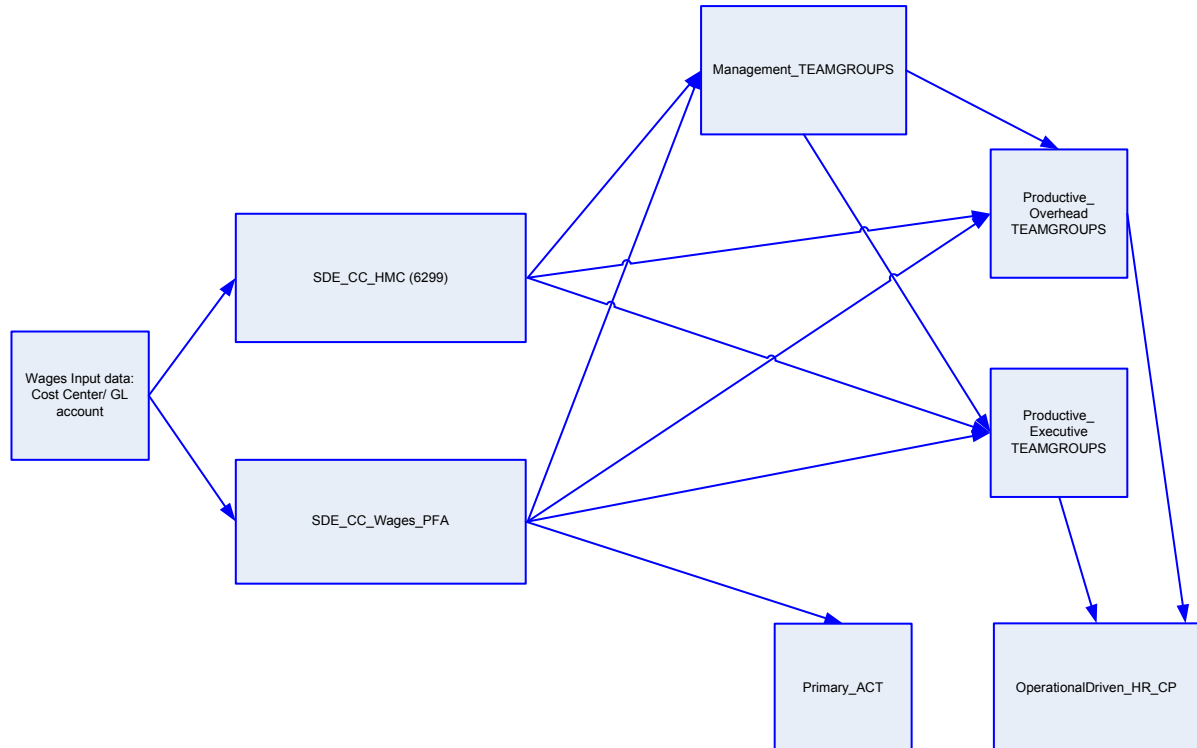

Figure 12**Step4-**

A fourth step is introduced to “cascade” the costs of the management teams onto the productive (productive_overhead and productive_executive) teams managed by them. The output objects are defined in the module “OperationalDriven_HR_CP”, each object being an executive teamgroup. At this point in the allocation stream a neat separation can be done between IT related costs (IT teamgroups) and nonIT related costs (nonIT teamgroups).

The allocation is summarized in the following stream:

**Figure 13**

We have chosen to describe this allocation stream in the context of remuneration cost allocation, but the same allocation flow remains valid for any OPEX costs driven by HR.

To summarize:

- Each Management teamgroup’s costs are cascaded to its managed Productive_Overhead (non IT) teamgroups and Productive_Executive teamgroups (NW and IT).
- Each Productive_Overhead’s teamgroup’s costs are directly sent to the combination of its supported Productive_Executive teamgroups and assigned activities.

The cost pool “salaries” and the personnel costs linked to SDE employees are allocated to the activities thanks to this methodology.

All these are processed in “Network & IT OPEX de-aggregation” box and ending in a cost object of the module “OPERATIONAL_DRIVEN_HR_CP” of the Sub Model.

5.1.3 GL60 accounts – Material Out of Stock

The GL60 account costs cover the cost of all kinds of material taken out of the stocks of Belgacom and used for the repair and provisioning of network or the cost of small items (office material, GSM,...) consumed by the staff in the context of their daily activities.

Note that movements from stock also occur for the construction of the network; these costs are capitalized. From SAP-MM, it is possible to filter out the movements to be capitalized and the others. The capitalized MOS costs are implicitly treated with the assets.

MOS costs are reported at GL account level per cost center, for example :

CC 2010description	GL description	Module	COST (EUR)
494000 LOGISTICS-MGT	60903000 Incr.-Decr. copper cables	CP2	6.414
494000 LOGISTICS-MGT	60904000 Incr.-Decr. copper splicing material	CP2	573
494000 LOGISTICS-MGT	60904000 Incr.-Decr. copper splicing material	NE	1.408
494000 LOGISTICS-MGT	60905000 Incr.-Decr. SDH equipment	CP2	36.090
494000 LOGISTICS-MGT	60905000 Incr.-Decr. SDH equipment	CP2	1.820

This level is too high to allow an accurate attribution of the costs to the model cost objects and therefore an analysis is performed at the SAP-MM record level.

- The SAP records are reported among other detailed information such as the Material Item Number, where the amounts can be directly attributed to a cost object of the cost model based on the description of the material item.

More than 21000 different Material Items are analysed; each item is directly attributed to a model cost object, an extract of this exercise is provided in the next table :

Cost center	GL description	Material Number	Description	Text CO	Amount	Destination
494000 LOGISTICS-MGT	60902500 Incr.-Decr. installation material	90032301	subrack OF empty			CP_fibre infrastructure
494000 LOGISTICS-MGT	60902500 Incr.-Decr. installation	90036200	FO GSS 2 subrack	FO GSS 2 subrack		CP_fibre infrastructure

	material					
494000 LOGISTICS- MGT	6090250 0 Incr.- Decr. installati on material	90038560	FO 19 GSS SUBRACK BMB	"FO 19" GSS SUBRAC K BMB		CP_fibre infrastructure
494000 LOGISTICS- MGT	6090300 0 Incr.- Decr. copper cables	83202069	Koperkabel Distributie 20p 0,6 mm			CP_Copper_Burried_Cables &Splices
494000 LOGISTICS- MGT	6090300 0 Incr.- Decr. copper cables	83205062	Koperkabel Distributie 50p 0,6 mm			CP_Copper_Burried_Cables &Splices
494000 LOGISTICS- MGT	6090300 0 Incr.- Decr. copper cables	83220061	Koperkabel Distributie 200 p 0,6 mm			CP_Copper_Burried_Cables &Splices
494000 LOGISTICS- MGT	6090300 0 Incr.- Decr. copper cables	83220061	Koperkabel Distributie 200 p 0,6 mm	Câble Cuivre Distribut ion 200 p 0,6 mm		CP_Copper_Burried_Cables &Splices
500000 COP-MST	6090500 0 Incr.- Decr. SDH equipm ent	90021256	SMA-4 MC WITH F/WARE R1.2 - REPAIR			CP_SDH
500000 COP-MST	6090500 0 Incr.- Decr. SDH equipm ent	90021263	SMA-1 SWITCH - REPAIR			CP_SDH
500000 COP-MST	6090540 0 Incr.- Decr. DSL material	90037097	IAR FD SPLITTER CARD POTS+ISDN (NVSU-B)			CP_VDSL2

500000 COP-MST	6090540 0 Incr.- Decr. DSL material	90037143	IAR FD LT48 VDSL2/ISDN ISAM only(NVLT-D)			CP_VDSL2
500000 COP-MST	6090540 0 Incr.- Decr. DSL material	90037224	IAR SB-REM FAN Unit - NO FILTER (NRFU- A)			CP_VDSL2
504555 A1 MASS MARKET PILA	6094030 0 Stock variatio n simple terminal s	90028630	BAT. Alk.1,5V LR03X/4B/AA A	BAT. Alk.1,5V LR03X/4 B/AAA		15002 CPE Other
504555 A1 MASS MARKET PILA	6094030 0 Stock variatio n simple terminal s	90028632	BAT. Alk.1,5V LR6X/4B/AA			15002 CPE Other
504555 A1 MASS MARKET PILA	6094030 0 Stock variatio n simple terminal s	90028632	BAT. Alk.1,5V LR6X/4B/AA	BAT. Alk.1,5V LR6X/4B /AA		15002 CPE Other
504555 A1 MASS MARKET PILA	6094200 0 Stock variatio n IDTV	14010016	Belgacom TV 3*RCA M-M 1,5m	Belgaco m TV 3*RCA M-M 1,5m		14001 TV and VoD
504555 A1 MASS MARKET PILA	6094200 0 Stock variatio n IDTV	14010108	BGC TV Devolvo AV Easy PassTru duo			14001 TV and VoD
504555 A1 MASS MARKET PILA	6094200 0 Stock variatio n IDTV	14010108	BGC TV Devolvo AV Easy PassTru duo	BGC TV Devolvo AV Easy PassTru duo		14001 TV and VoD
504555 A1 MASS MARKET PILA	6094200 0 Stock variatio n IDTV	14010109	BGC TV Devolvo AV Easy PassTru single	BGC TV Devolvo AV Easy PassTru single		14001 TV and VoD

504560 A1 MASS MARKET XDSL	6090300 0 Incr.- Decr. copper cables	81029260	8 10 292 6 FREP 10 W/R 2x0,6.	8 10 292 6 FREP 10 W/R 2x0,6.		NE_Broadband Drop
504560 A1 MASS MARKET XDSL	6090300 0 Incr.- Decr. copper cables	81290261	Binnenkabel DSL 2paar 200m			NE_Broadband Drop
504560 A1 MASS MARKET XDSL	6090300 0 Incr.- Decr. copper cables	81290261	Binnenkabel DSL 2paar 200m	Binnenk abel DSL 2paar 200m		NE_Broadband Drop
504560 A1 MASS MARKET XDSL	6090420 0 Incr.- Decr. FO splic mat & tools & OMDF	76202100	FIST SPLICE TRAY MARKER (10 st)	FIST SPLICE TRAY MARKER (10 st)		CP_fibre infrastructure
504560 A1 MASS MARKET XDSL	6090430 0 Incr.- Decr. ducts & sealing caps	90025246	Buis grijs PVC hard 16 mm - 3 M	Buis grijs PVC hard 16 mm - 3 M		CP_Ducts&Manholes
504650 A2 OUTSOURC ING MM/PM	6090540 0 Incr.- Decr. DSL material	90037240	Tussenstekker DSL 5M-6F	Tussenst ekker DSL 5M- 6F		NE_ADSL equipment
504650 A2 OUTSOURC ING MM/PM	6090540 0 Incr.- Decr. DSL material	90039192	RJ11-ADC CORD FOR MULTICABLE	RJ11- ADC CORD FOR MULTIC ABLE		NE_ADSL equipment
504660 PROF MARKET A2.1	6094124 0 Stock variatio n large PABX	90027617	Belgacom Video Doorphone 1,2,4 R&R			15002 CPE Other
504660 PROF MARKET A2.1	6094124 0 Stock variatio n large PABX	90027617	Belgacom Video Doorphone 1,2,4 R&R	Belgaco m Video Doorph one 1,2,4 R&R		15002 CPE Other

504750 A3 PROF MARKET 2	6090400 0 Incr.- Decr. copper splicing material	76557107	DOORVOERDI CHTING 50 MM KAP			CP_Copper_Burried_Cables &Splices
504750 A3 PROF MARKET 2	6090400 0 Incr.- Decr. copper splicing material	76557115	DOORVOERDI CHTING 125MM KAP			CP_Copper_Burried_Cables &Splices
505750 OPTICAL AREA 3	6090430 0 Incr.- Decr. ducts & sealing caps	90033966	subduct indoor LSZH 12x2mm	subduct indoor LSZH 12x2mm		CP_Ducts&Manholes
505750 OPTICAL AREA 3	6090430 0 Incr.- Decr. ducts & sealing caps	90033993	Straightconne ctor 12mm subduct 50pc			CP_Ducts&Manholes
505750 OPTICAL AREA 3	6090430 0 Incr.- Decr. ducts & sealing caps	90034720	gasbloc con 12mm Gabo 5/6,5mm 40pc			CP_Ducts&Manholes

This analysis results in an allocation towards : network related cost pools (CP2, NE, OVH, NLS), manpower related cost pools (FLAG module objects MOSFTE_per_cc), activities & ABC products.

Once each material item is attributed to a cost object, it is easy to report an allocation from the CC/GL account aggregate to the model cost objects.

For those Cost Center / GL combinations for which the reconciliation is weak, either the amounts are not material or the GL denomination alone allows a direct attribution to one model cost object.

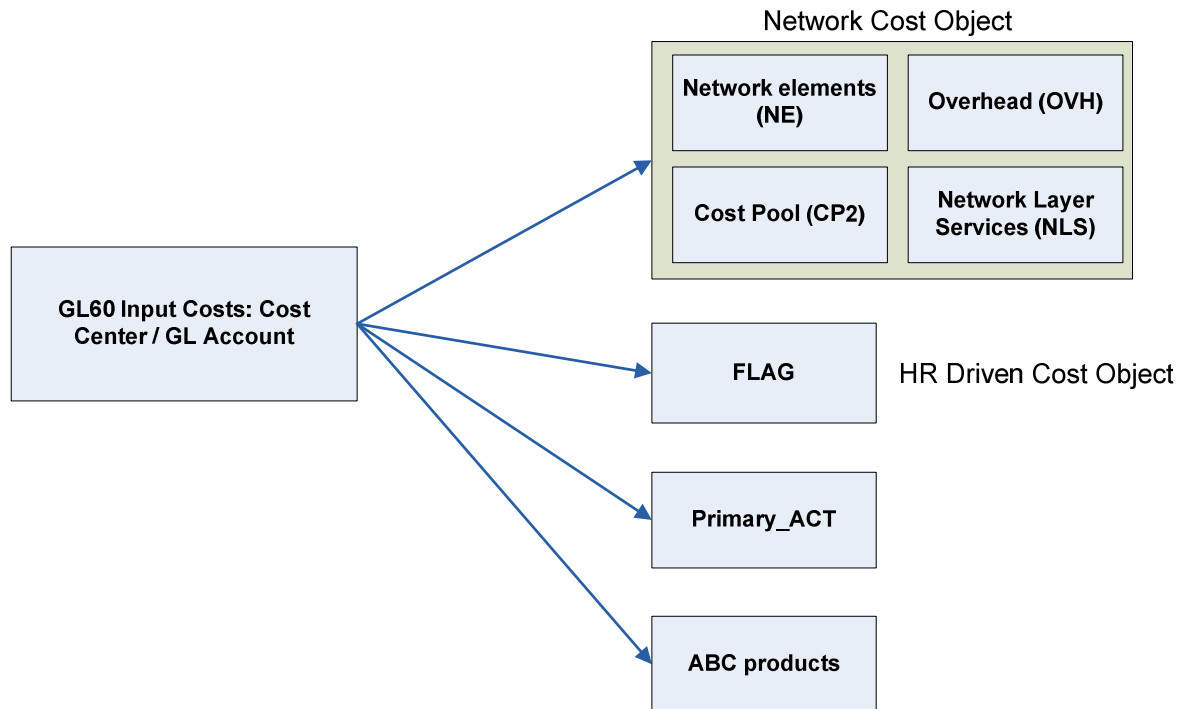

Figure 14

5.2 Allocation of teamgroups to NW or customer-related activities

1° NW and customer-related activities

There are 53 NW or customer-related activities applying to 50_SDE :

2.5.1. Execute remote provisioning – Mass
2.5.2. Execute remote provisioning – Prof
2.6.3. Dispatch, monitor and close provisioning work orders (not related to the cable)
2.6.6. Dispatch, monitor and close provisioning Cu splicing work orders related to the introduction cable
2.7.3. Execute field provisioning
2.8.4. Manage projects related to the provisioning of telecom & IT solutions – Prof
2.9.1. ICT service provisioning
2.9.2. ICT Data Center provisioning for Customer
2.9.3. ICT Security & System Integration provisioning for Customer
2.10.1. Mobile service provisioning
3.2.2. Provide Customer Service/SLA management - Prof
3.4.1. Execute fault handling & remote repair - Mass
3.4.2. Execute fault handling & remote repair - Prof
3.5.3. Dispatch, monitor and close repair work orders (not related to the cable)
3.5.6. Dispatch, monitor and close Cu splicing work orders related to the repair of cable network
3.6.3. Execute field repair
3.7.1. ICT service repair - 1st handling
3.7.2. ICT monitoring & service repair - 2nd handling
3.7.3. ICT Data Center repair for Customer
3.7.4. ICT Security & System Integration repair for Customer

3.8.1. Mobile services support
5.1.1. NW Infrastructure Engineering
5.1.2. NW Product & Service Engineering
5.2.1. Fixed NW Plan Backbone Inside plant works and document
5.2.2. Fixed NW Plan Access Inside plant works and document
5.2.3. Fixed NW Backbone Inside Installation
5.2.4. Fixed NW Access Inside Installation
5.2.5.1. Fixed NW Infrastructure Remote Configuration
5.2.5.2. Mobile NW Infrastructure Remote Configuration
5.2.6.1. Fixed NW Voice Service Remote Configuration
5.2.6.2. Mobile NW Voice Service Remote Configuration
5.2.7.1. Fixed NW Data&TV&Actg&Authorization Service Remote Configuration
5.2.7.2. Mobile NW Data&TV&Actg&Authorization Service Remote Configuration
5.2.8. Fixed NW Plan outside plant works and document
5.2.9. NW Plan plant works, Solution design & Engineering for VHR/Industrial zonings
5.2.10. Fixed NW (Supervision, coordination and inventory) Outside construction
5.2.12. NW Access Outside - VHR/Radio for customer
5.2.13. Fixed NW Access Outside - copper work for customer
5.2.20. Mobile NW Planification, Configuration & (supervision) Construction
5.3.1. Fixed NW Backbone Inside Maintenance & Repair
5.3.2. Fixed NW Access Inside Maintenance & Repair
5.3.4. Fixed NW Access Outside Maintenance & Repair - FO/ROP
5.3.5. Fixed NW Access Outside Maintenance & Repair - VHR/Radio
5.3.6. Fixed NW Access Outside Maintenance & Repair - Cable
5.3.8.1. Fixed NW Voice service level Maintenance & Remote Repair
5.3.8.2. Mobile NW Voice service level Maintenance & Remote Repair
5.3.9.1. Fixed NW Data&TV&Actg&Authorization service level Maintenance & Remote Repair
5.3.9.2. Mobile NW Data&TV&Actg&Authorization service level Maintenance & Remote Repair
5.3.10.1. Fixed NW Infrastructure Maintenance and Remote Repair
5.3.10.2. Mobile NW Infrastructure Maintenance and Remote Repair
5.3.11.1. Fixed NW Infrastructure Monitoring
5.3.11.2. Mobile NW Infrastructure Monitoring
5.3.20. Mobile NW Monitoring, Maintenance & Repair

- For the purpose of OPEX cost allocation of SDE, the department REG has grouped all SDE teams (NW and IT) into three types of teamgroups :
 - Productive_Executive teamgroups,
 - Productive_Overhead teamgroups,
 - Management teamgroups.
- Productive_Executive teamgroups have been assigned with NW activities for which they are mainly responsible.
- IT related Productive_Executive teamgroups have not been assigned with IT activities. Their OPEX costs are allocated to IT Constellations.
- Productive_Overhead teamgroups provide support to Productive_Executive teamgroups.

- Management teamgroups manage Productive_Overhead teamgroups and Productive_Executive teamgroups.

2° Allocation of Productive_Executive teamgroups to NW and customer-related activities

Division	Productive_Executive Teamgroup	Driver	Destination
50_SDE	COP-CFOx-CAB	DU	5.2.13. Fixed NW Access Outside - copper work for customer
50_SDE	COP-CFOx-CAB	DU	5.3.6. Fixed NW Access Outside Maintenance & Repair - Cable
50_SDE	COP-CFOx-IDC-CABLE	DU	2.6.6. Dispatch, monitor and close provisioning Cu splicing work orders related to the introduction cable
50_SDE	COP-CFOx-IDC-CABLE	DU	3.5.6. Dispatch, monitor and close Cu splicing work orders related to the repair of cable network
50_SDE	COP-CFOx-IDC-MASS	DU	2.6.3. Dispatch, monitor and close provisioning work orders (not related to the cable)
50_SDE	COP-CFOx-IDC-MASS	DU	3.5.3. Dispatch, monitor and close repair work orders (not related to the cable)
50_SDE	COP-CFOx-IDC-PROF	DU	2.6.3. Dispatch, monitor and close provisioning work orders (not related to the cable)
50_SDE	COP-CFOx-IDC-PROF	DU	3.5.3. Dispatch, monitor and close repair work orders (not related to the cable)
50_SDE	COP-CFOx-IDC-Support	DU	2.6.3. Dispatch, monitor and close provisioning work orders (not related to the cable)
50_SDE	COP-CFOx-IDC-Support	DU	3.5.3. Dispatch, monitor and close repair work orders (not related to the cable)
50_SDE	COP-CFOx-MAS	DU	2.7.3. Execute field provisioning
50_SDE	COP-CFOx-MAS	DU	3.6.3. Execute field repair
50_SDE	COP-CFOx-PRF	DU	2.7.3. Execute field provisioning
50_SDE	COP-CFOx-PRF	DU	3.6.3. Execute field repair
50_SDE	COP-CRO-CHC	FTE	3.4.1. Execute fault handling & remote repair - Mass
50_SDE	COP-CRO-IAC	FTE	2.5.1. Execute remote provisioning - Mass
50_SDE	COP-CFOx-PCD	FTE	2.5.1. Execute remote provisioning - Mass
50_SDE	COP-EIS-ISD-CIS-INT	FTE	7.1.1. End user support for BGC SA employees (IT)
50_SDE	COP-EIS-ISD-CIS-EXT	FTE	7.1.3. End user support for external customers (IT)
50_SDE	COP-EIS-NUC-CNN	FTE	2.8.4. Manage projects related to the provisioning of telecom & IT solutions - Prof
50_SDE	COP-EIS-NUC-ICT	FTE	2.9.1. ICT service provisioning
50_SDE	COP-EIS-NUC-MCC	FTE	2.10.1. Mobile service provisioning
50_SDE	COP-EIS-CNN	FTE	2.5.2. Execute remote provisioning - Prof
50_SDE	COP-EIS-ISD-RPC	FTE	3.4.2 Execute fault handling & remote repair - Prof
50_SDE	COP-EIS-SID	FTE	3.2.2. Provide Customer Service/SLA management - Prof
50_SDE	COP-EIS-SIN-SDC	FTE	2.9.2. ICT Data Center provisioning for Customer
50_SDE	COP-EIS-SIN-SDC	FTE	3.7.3. ICT Data Center repair for Customer
50_SDE	COP-EIS-SIN-ASO	FTE	2.9.3. ICT Security & System Integration provisioning for

			Customer
50_SDE	COP-EIS-SIN-ASO	FTE	3.7.4. ICT Security & System Integration repair for Customer
50_SDE	COP-EIS-SIN-SEC	FTE	2.9.3. ICT Security & System Integration provisioning for Customer
50_SDE	COP-EIS-SIN-SEC	FTE	3.7.4. ICT Security & System Integration repair for Customer
50_SDE	COP-EIS-SIN-ZOD	FTE	2.9.3. ICT Security & System Integration provisioning for Customer
50_SDE	COP-EIS-SIN-ZOD	FTE	3.7.4. ICT Security & System Integration repair for Customer
50_SDE	COP-EIS-ISD-USD	FTE	3.7.1. ICT service repair - 1st handling
50_SDE	COP-EIS-ISD-ROC/SSC	FTE	3.7.2. ICT monitoring & service repair - 2nd handling
50_SDE	COP-EIS-ISD-MSS	FTE	3.8.1. Mobile services support
50_SDE	IDO-FXx-BND-EQE	FTE	5.2.1. Fixed NW Plan Backbone Inside plant works and document
50_SDE	IDO-FXx-BND-EQE	FTE	5.2.2. Fixed NW Plan Access Inside plant works and document
50_SDE	IDO-FXx-BND-IDE	FTE	5.2.8. Fixed NW Plan outside plant works and document
50_SDE	IDO-FXx-BND-IDE-VHR	FTE	5.2.9. NW Plan plant works, Solution design & Engineering for VHR/Industrial zonings
50_SDE	IDO-FXx-BND-EQE-VHR	FTE	5.2.9. NW Plan plant works, Solution design & Engineering for VHR/Industrial zonings
50_SDE	IDO-FXx-IMR-xxx	FTE	5.2.3. Fixed NW Backbone Inside Installation
50_SDE	IDO-FXx-IMR-xxx	FTE	5.3.1. Fixed NW Backbone Inside Maintenance & Repair
50_SDE	IDO-FXx-IMR-xxx	FTE	5.3.2. Fixed NW Access Inside Maintenance & Repair
50_SDE	IDO-FXx-IMR-xxx	FTE	5.2.4. Fixed NW Access Inside Installation
50_SDE	IDO-FXx-LPE-xxx	FTE	5.2.10. Fixed NW (Supervision, coordination and inventory) Outside construction
50_SDE	IDO-FXx-OPT-OUT	FTE	5.3.4. Fixed NW Access Outside Maintenance & Repair - FO/ROP
50_SDE	IDO-FXx-OPT-VHR	FTE	5.2.12. NW Access Outside - VHR/Radio for customer
50_SDE	IDO-FXx-OPT-VHR	FTE	5.3.5. Fixed NW Access Outside Maintenance & Repair - VHR/Radio
50_SDE	IDO-FXx-OPT-Radio	FTE	5.2.12. NW Access Outside - VHR/Radio for customer
50_SDE	IDO-FXx-OPT-Radio	FTE	5.3.5. Fixed NW Access Outside Maintenance & Repair - VHR/Radio
50_SDE	IDO-OPE-DC	FTE	IT_Housing_for_ExternalCustomers
50_SDE	IDO-OPE-DC	FTE	IT_Building_Management
50_SDE	IDO-TRS-ANC-DC-INS-OP	FTE	IT_Housing_for_ExternalCustomers
50_SDE	IDO-TRS-ANC-DC-INS-OP	FTE	IT_Building_Management
50_SDE	IDO-MOB-xxx	FTE	5.2.20. Mobile NW Planification, Configuration & (supervision) Construction
50_SDE	IDO-FXx-WOS	FTE	5.2.20. Mobile NW Planification, Configuration & (supervision) Construction
50_SDE	IDO-MOB-xxx	FTE	5.3.20. Mobile NW Monitoring, Maintenance & Repair
50_SDE	IDO-FXx-WOS	FTE	5.3.20. Mobile NW Monitoring, Maintenance & Repair
50_SDE	SDV-NIE-CAT	FTE	5.1.1. NW Infrastructure Engineering
50_SDE	SDV-NIE-CPE	FTE	5.1.1. NW Infrastructure Engineering

50_SDE	SDV-NIE-DOT	FTE	5.1.1. NW Infrastructure Engineering
50_SDE	SDV-NIE-LAB	FTE	5.1.1. NW Infrastructure Engineering
50_SDE	SDV-NIE-PLE	FTE	5.1.1. NW Infrastructure Engineering
50_SDE	SDV-NIE-WAT	FTE	5.1.1. NW Infrastructure Engineering
50_SDE	SDV-PSE-DAC	FTE	5.1.2. NW Product & Service Engineering
50_SDE	SDV-PSE-VID	FTE	5.1.2. NW Product & Service Engineering
50_SDE	SDV-PSE-VCI	FTE	5.1.2. NW Product & Service Engineering
50_SDE	SDV-PSE-MNS	FTE	5.1.2. NW Product & Service Engineering
50_SDE	SIO-CSC-NOC-NW	FTE	5.3.11.1. Fixed NW Infrastructure Monitoring
50_SDE	SIO-CSC-NOC-NW	FTE	5.3.11.2. Mobile NW Infrastructure Monitoring
50_SDE	SIO-CSC-SSD	FTE	5.3.11.1. Fixed NW Infrastructure Monitoring
50_SDE	SIO-CSC-SSD	FTE	5.3.11.2. Mobile NW Infrastructure Monitoring
50_SDE	SIO-CSC-SSD	FTE	Application_Interaction_Platform
50_SDE	SIO-INO-DSP	FTE	5.2.7.1. Fixed NW Data&TV&Actg&Authorization Service Remote Configuration
50_SDE	SIO-INO-DSP	FTE	5.2.7.2. Mobile NW Data&TV&Actg&Authorization Service Remote Configuration
50_SDE	SIO-INO-DSP	FTE	5.3.9.1. Fixed NW Data&TV&Actg&Authorization service level Maintenance & Remote Repair
50_SDE	SIO-INO-DSP	FTE	5.3.9.2. Mobile NW Data&TV&Actg&Authorization service level Maintenance & Remote Repair
50_SDE	SIO-INO-TIO	FTE	5.2.5.1. Fixed NW Infrastructure Remote Configuration
50_SDE	SIO-INO-TIO	FTE	5.2.5.2. Mobile NW Infrastructure Remote Configuration
50_SDE	SIO-INO-TIO	FTE	5.3.10.1. Fixed NW Infrastructure Maintenance and Remote Repair
50_SDE	SIO-INO-TIO	FTE	5.3.10.2. Mobile NW Infrastructure Maintenance and Remote Repair
50_SDE	SIO-INO-VSP	FTE	5.2.6.1. Fixed NW Voice Service Remote Configuration
50_SDE	SIO-INO-VSP	FTE	5.2.6.2. Mobile NW Voice Service Remote Configuration
50_SDE	SIO-INO-VSP	FTE	5.3.8.1. Fixed NW Voice service level Maintenance & Remote Repair
50_SDE	SIO-INO-VSP	FTE	5.3.8.2. Mobile NW Voice service level Maintenance & Remote Repair

Productive_Executive teamgroups are mainly allocated to NW & customer-related activities as follows:

- direct allocation, if a teamgroup has been assigned with only one activity. This is the major case for SDE SDV teamgroups.
- on the basis of the work hours performed, if a teamgroup has been assigned with more than one activity. The reporting systems used are CLARA for SDE COP CFO CAB Mass & Professional teamgroups, ABB for SDE SIO teamgroups and LEAD, JMS and CANVAS for SDE IDO teamgroups. Those work hours have been translated into the different driver quantities by taking into account standard time per activity:

- DU (Dispatching Units) as driver quantity for SDE COP CABLE, Mass & Professional teamgroups,
- Effort by technology as driver quantity for SDE SDV teamgroups for network engineering activity and product engineering activity,
- FTE as driver quantity for SDE IDO teamgroups for network field construction activities and network field repair activities,
- FTE as driver quantity for SDE SIO teamgroups for network remote configuration activities and network remote repair&maintenance activities.

6 IT stream

6.1 IT delivery

6.1.1 IT Sub-Model: Introduction

The IT Sub-model has been changed in a radical way compared to the 2008 version. As recommended by the auditor in the frame of the audit of the 2007 cost model, causal keys have again been used as from the 2009 cost model (instead of a 6% mark-up as computed in the BIPT cost models) in order to integrate IT Costs to the global regulatory model. In the 2010 cost model, the mobile architecture is also taken into account from Belgacom Mobile.

This new IT Sub-model can be summarized by the following drawing which represents the different IT Modules as defined in the IT model, as well as describing objects contained in each of them. The creation of these modules and objects will be detailed as well as how they are allocated to each ABC product through an allocation which uses causal and generic keys created with data available in different inventories or reporting systems within the company.

As an introduction to the IT Allocation, the following diagram will explain the philosophy behind the IT Sub-model, although a more detailed explanation will be available further on. ICT is the use of programs with a specific infrastructure to deliver a requested service or product to the end-user (which can be a Belgacom Client or a Belgacom Employee). In Telecommunications, rarely will we encounter an Application that is exclusively being used by one product. Most of the time, it will be used by many different products. Therefore, the goal of this model is to regroup all capitalized and operational costs within clusters of applications that have been defined so that the link to ABC products can easily be made. As illustrated below, all costs are regrouped within applications or IT domains which are merged into IT Constellations: a concatenation of a process with a set of Products (for Instance, IT_Fulfillment_PILA will regroup all applications used by the fulfillment Process for PILA products). IT Constellations can also be a product like IT_IDTV which regroups all IT Applications used to deliver IDTV as a commercial product, although this is very rare.

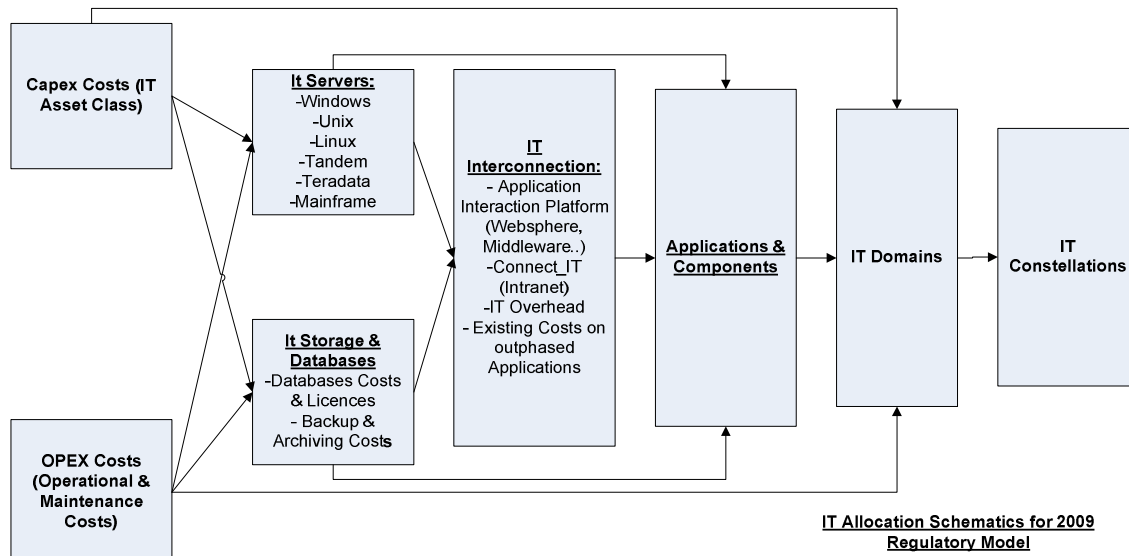

Figure 15

It should be noted that reporting systems and inventories either report to an application and its component or to an IT Domain. Among more than a thousand applications, IT engineering defined more than 275 Domains for reporting purposes and their definition were adapted into the IT Sub-Model in order to give coherence over the years. The allocation stream goal is to link applications, components and domains to the manpower and infrastructure costs that are used in order to create, run and maintain them.

These costs can be of two different types: capitalized and therefore depreciated following accounting rules (for IT, depreciation length is mostly 4 or 5 years), or operational and fully charged for the current year. Depending of the cost's nature, the allocation stream will follow a different path and use different inventories and reporting systems in order to create the optimal allocation keys.

Accounting has defined, for capitalized costs, 135 IT assets or sub-assets which can be easily identified as distinctive IT objects in the model. Inventories and accounting provided the raw data needed in order to create the allocation keys.

6.1.2 Data sources: IT Inventories and Reporting Systems:

6.1.2.1 Infrastructure and Hardware Inventory:

The hardware layer of the IT Infrastructure within Belgacom is composed of a server park, a storage facility and an intranet required to interconnect them. For Servers allocation, three inventories were used to populate the park and gain depth in their use. WMC¹ (Windows Management Console), LMC² (Linux Management Console) and Sun:bc for UNIX are databases

¹ Windows Management Console

² Linux Management Console

maintained by IT Engineering. Regarding Storage, the reporting system can extract all directories paths names on Belgacom's hard-drives with the storage space it uses. This path is defined, in most cases, by its purpose such as an application name, or a database name and type. Most reports used by the 2010 Model were retrieved from these systems during the period of December 2010 to March 2011 in order to be complete since there is a lapse of time between the validation for purchasing IT hardware for projects, its installation and getting an update in the inventories.

6.1.2.2 Internal IT Databases:

The main database used in the model is the "Configuration Management Database" (CMDB) which populates and links together all IT related objects in Belgacom, such as which databases are used by an application, or what is hosted on a server. This is used primarily for incident management.

IT Asset Manager (ITAM) is the inventory for all IT equipments with a reference to its cost and is used by Finance to calculate yearly the costs for most IT hardware Assets.

ARIS is a recent initiative to install a business process modeling tool which helped in the aggregation of applications and the definition of domains and constellations.

IMA is the Identifier management system for IT applications. It identifies, authorizes and manages access for Belgacom's users (customers, suppliers, employees...). It allows us to know the number of users per application which is an estimation of the weight of an application. This information will be helpful in the allocation of shared environments, where the same server runs multiple applications.

6.1.2.3 Reporting Systems:

Rapid³ is a tool used for projects, budget and capacity management related processes, with interfaces to other core systems such as SAP HR (human resource & organization units data), SAP Finance (actuals, purchase order..), IMD (release Management) and timesheets applications (used by SDE to report their day-to-day work). Rapid will be used to calculate allocation keys for most manpower costs for SDE, Capex (allocation of Assets ranging from 2526 to 2573) and Opex.

Regarding maintenance and contractors, the data is maintained by the vendor management team and retrieved on their private sharepoint where a quarterly report is made available with all financial details (actuals, general ledger account n°, cost center...) as well as vendors details (name of the product vendor and the subcontractor, contract name...)

TM1 is an interface from excel to SAP allowing the extraction of Data coming from Finance and HR.

6.1.3 Modules and Objects composing the IT Sub-Model

6.1.3.1 IT Servers

A server is a computer running as a service to serve the needs or requests of others programs or users. They are bought off several vendors which use different technology types. These machines

³ Repository for the Administration of Projects and Initiatives in a Decentralized way

are upgraded on a frequent basis in terms of memory, CPU cache and quantity or i/o cards. This results in a heterogeneous park of servers, even for a similar model sold by the same vendor, having a negative effect in terms of cost variance. Hence was followed an approach which splits the servers into families based on their technology. This was done for two reasons: firstly, it matches the operational organization within Belgacom, helping in coherence and giving us the opportunity to have for each family an expert available to help, backed up by dedicated inventories. Secondly, families follow a logical flow of cost allocation. Windows machines can be split in three categories (low-end, high-end and for Virtualization) to which we apply a weight based on their raw cost in order to give more consistency to the data used. This is done because the variance between servers in these 3 categories is much lower than by taking the whole Windows family as a whole. Linux servers use all the same hardware as Windows low-end for 99% of them. UNIX servers are bought on the CPU power needed, called TPMC⁴ and which we will use to ventilate UNIX costs. Finally Teradata, Tandem and Mainframes machines will be directly allocated to the applications that use these special technologies.

Splitting the server asset between these families was possible by the use of a specific reporting that is done yearly by Finance.

a) Windows family

Windows is split between three categories: low-end, high-end and VM⁵ Performance. Virtualization machines use a software layer to emulate more (virtual) servers with the possibility of using different operating systems or environments, helping to rationalize resources (by allowing more redundancy, saving space etc.). Weights were created from the cost model made by IT engineering and purchasing costs for low-end, high-end and “VM Performance” servers were used. The key to allocate windows costs is based on the number of servers multiplied by its corresponding weight and the destination is either another object from the model or, generally, an application.

b) Linux Family

The linux park uses low-end machines only, therefore their costs are homogeneous, allowing us to create a key based on the number of servers per IT object.

c) UNIX Family

UNIX Machines are allocated in the same way purchasing and engineering estimate the optimal amount of resources required for an IT object to run efficiently. This is achieved through an indicator named TPMC⁶ which estimates processing power of a machine. As HP and SUN (main vendors for UNIX servers) sell their machines in euro per TPMC, it is a good allocation key to use in order to increment a cost per server for the UNIX family.

⁴ Transaction per Minute (type C)

⁵ Virtual Machines

⁶ Transaction per minute (type C)

d) Teradata and Tandem Families:

Teradata are servers specifically used by the Data Warehouse and will be directly allocated to the corresponding cluster.

Tandem machines are non-stop servers for the Customer Billing application and will be directly allocated to its corresponding cluster.

e) Mainframes family

Mainframes are used by a small group of specific applications and will be allocated according to an IMA key based on the number of users for each application using directly mainframe resources.

6.1.3.2 Storage

In the storage tool, reported directories paths have been assigned the name of an application or a database in their path. It allows us to know precisely the amount of storage used by each application, database or another object in the sub-model such as Websphere in interconnection. These are the most intensive objects in terms of storage. In order to allocate costs from databases to applications, we used a report from each database family operational team (Oracle, SQL, Teradata and IDMS) to map databases with applications and to create allocation keys based on the total size of the databases used by each application.

6.1.3.3 IT Interconnection**a) Connect IT:**

Connect IT is the Intranet used by the IT infrastructure in order to inter-connect the different objects it uses to deliver a service. The allocation will be based on a post-process generic key defined by the CAPEX cost of servers. Since there is a direct correlation between a server's cost and the data it sends and receives (through its i/o card which is one of the main contributor to a server's cost), we consider that a server's cost is representative of its use of intranet.

b) Application Interaction Platform:

The Application Interaction Platform object is defined as the software layer required to interconnect Belgacom's complex IT infrastructure. Websphere and middleware costs compose most of this object. Websphere Application Server (WAS) sets up, operates and integrates electronic business applications across multiple computing platforms allowing real-time application integration, event-driven processing and process automation. A middleware is a software component that provides interoperability in order to support and simplify complex distributed applications. It is an intermediary layer between application software working on different environments or operating systems. This object receives mostly costs from either middleware or websphere licenses, upgrades and the infrastructure costs it uses (mainly storage and servers).

c) IT Overhead

The overhead object is a pool of costs that manages the Belgacom's IT Infrastructure. It is internalized in the IT model.

6.1.4 Allocation Process for IT Assets and Operational Costs:

6.1.4.1 IT Assets

- **2500 Servers (Inclus. Tandem)**

Servers can be used by applications (software sold by a vendor or developed in-house) and databases or for interconnectivity and security. This asset pools most of servers families used within the company such as Windows, Linux, UNIX, Teradata and Tandem technologies. Accounting distinguishes the following families: Wintel (Windows for Telecommunication), UNIX (with Linux pooled in this family), Teradata and Tandem. Keys are created from Finance split in order to allocate costs to each family, which will be treated distinctively, following a specified allocation path depending on the technology.

Windows servers are allocated by applying a weight to the number of servers used by each IT object. These weights are calculated by using a cost-dependant ratio based on the raw purchasing costs of a windows server. We distinguished three categories of windows servers that reduce heavily the variance within the windows server family: the low-end, the high-end and vm-performance servers. Low-end machines are composed of most servers in the windows family. High-end ones are the latest end-entry models which generally use twice as much CPU's and memory than a low-end server. VM Performance machines pool the servers that are used to emulate more servers with a more powerful hardware than the last two categories.

Regarding the Linux family, no further splits were necessary as most Linux servers use a homogeneous hardware, bought and maintained by the Windows teams. The allocation key is based on the number of servers used by each application and IT object without any weight applied to it.

Tandem and Teradata are both allocated directly to their corresponding application: Customer Oriented Billing (COB) for Tandem and Data warehouse for Teradata (DWH).

Mainframes costs are distributed to the 7 applications that use this technology (ABD-FH, ABD-NFH, ABR, AGS, ASR, ITC and ITR) following an IMA key based on the number of users per application.

Finally, UNIX costs are allocated to other IT objects by using a TPMC statistic which is also used by purchasing and engineering. As stated previously, it estimates the computing power of a machine based on the transactions per minute it does.

- **2501 Storage:**

Storage for Belgacom is both a core business as well as a support for employees and customers. It is required in order to run applications and databases, create backup and archives to save an employee's work or a customer's information (regarding billing or call details records for instance).

For instance, the data warehouse works on internal statistics, heavily intensive on storage resources.

- **2502 Mainframe BS2000 HW & 2503 BS2000 Software:**

Mainframes are powerful computing platforms used for critical applications. They can be considered as multiple servers within one machine. Sensitive applications and data that require heavy computing power are hosted on them. It requires specific software to run which costs are pooled in the 2503 BS2000 Software asset. Mainframes used to be BS2000 machines but they were recently changed for Z-Series mainframes from IBM.

- **2504 IT Internal Network**

IT Internal Network is an asset representing Belgacom's Intranet, required to support the needs of employees as well as the interconnection needed in order for the different IT objects to communicate.

- **2505 Office Automation**

Office Automation pools IT costs and improves productivity such as development environment, mails exchange platform, printing servers etc. These costs are directly sent to the IT_OfficeAutomation constellation.

- **2506 End user IT Device**

Concerns IT material made available to Belgacom's employees such as laptops and desktops. It is an office automation cost.

- **2507 Office Automation SW Implementation:**

Related to Office Automation and will be allocated accordingly.

- **2508 Servers Implementation:**

Related to Servers and will be allocated accordingly.

- **2509 HW Usability Lab:**

Testing equipment and software for IT is pooled in the usability Lab. The 2509 asset concerns hardware and 2545 is related to software. As it concerns all applications within Belgacom, this cost is considered as an IT overhead and will be allocated as such.

- **2510 Facilities Invest. Data:**

Datacenters IT costs are pooled in this Asset. The number of physical servers running in those datacenters for each IT object was used as an allocation key to ventilate these costs as the place used in the racks for Belgacom's needs could bring revenue if rented to external customers.

- **2520 System Software:**

System software is an asset for all database and middleware applications costs (websphere for instance), mainly licenses and updates. Database is an object within the "IT_Storage&DB" module and middleware is a main contributor to the "Application_Interaction_Platform" object in the "IT_Interco" module. In order to split the costs, actual capex mandays for the year 2010 were used as RAPID records mandays consumed by the Databases and Middleware objects.

- **2521 System Software Implementation:**

Related to System Software asset and will be allocated accordingly.

- **2523 Major Software Application:**

This is a specific asset that pools applicative mobile costs. It contains IT sub-assets as well as network ones due to historical reason. Each element can be identified in terms of type (IT / Network) and costs (distribution per sub-asset), each one of them can directly be allocated to their corresponding domain or network element.

- **2525 Application Software Other:**

Application Software other is an asset for all Capex licenses costs that are not pooled in another IT asset (licenses costs for minor applications for instance). It is heavily related to applications and office automation as it is composed of licenses for antivirus, to a software package sold by an external vendor and used by an in-house core application such as our Order Management System (OMS) or statistical and databases manager for our data warehouse department. In order to allocate this key efficiently, the number of logical machines (physical and virtual) from each server related family was used as a means to ventilate these costs through the server allocation process.

- **2526 Applic SW IMA:**

All costs related to the **Identify Management (IMA)** application are assigned to this asset. IMA is composed of 6 components (Core, Employee, Dealers, Customer, Module, and Management) that identify all Belgacom users. They all form the A-IMA domain linked to "IT_Overhead" constellation, as it is an IT management tool.

- **2529 Appl SW Middleware:**

Although named Middleware, this asset is composed of special applications that play the role of a middleware inside Belgacom's IT infrastructure. It has to be distinguished from some costs objects

in System Software and Application Software Other that also have middleware costs such as Websphere licenses. The 4 main contributors in terms of costs are the following domains:

- A **Business Process Modeler** (A-BPM Domain) which delivers a process integration platform for enterprise services based on service-oriented architecture.
- A **Service Oriented Architecture** layer (A-SOA Domain).
- A **SOA Services Repository** (A-SSR Domain) to document and describe all SOA services.
- And a **Hub Contract Software** (A-HCS Domain) used as a middleware connectivity tool.

There are two minor contributors for around 4% of the asset cost that are related to databases and to the “application_interaction_platform” object. All these costs are reported in RAPID with a specific domain that exists as an object in the IT sub-model. Capex mandays costs per domain for year 2010 reported in this asset are used as an allocation key.

- **2530 Applic. SW PILA:**

Pila Asset is composed of 20 applications and components related to the **Order handling Management System** (OMS) with all its bridges with provisioning systems and a customer relationship management interface with BCI as well. The A-OMS domain is one of the main contributors to this asset, as is the **Network Provisioning System** (A-NPS Domain) linking OMS with provisioning systems and the **Order Flow Application** (A-OFA Domain: an interface between BCI and OMS). A split is also available for all costs related to NPS leased lines (A-NPS LLD Domain). As for most applicative assets, CAPEX mandays reported in RAPID are used to create keys to allocate the asset to each IT domain. Most of them are mapped to the “IT_Fulfillment_PILA” constellation with the exception of the A-NPS LLD domain mapped to IT_Fulfillment_LeasedLines. This split has been introduced in 2010 for OMS and earlier for NPS allowing us to use the 2005 to 2010 capex key for NPS, and only for 2010 for OMS 1C.

- **2531 Applic. SW BCI:**

The Belgacom Channel Integration (BCI) is a customer relationship management tool for all call-centers. This asset is composed of 15 components all related to the A-BCI Domain enabling a real-time customer information input or output in order to improve the feedback a customer receives when calling Belgacom’s helpdesks. All costs from BCI applications are allocated directly to the **Customer Relationship Management** constellation: IT_CRM.

- **2532 RID(Reference Inventory&Design):**

RID is an asset related mostly to inventories and documentation that are used in different processes as it pools 6 different Domains. This asset is allocated accordingly to capex mandays reported in RAPID (and its predecessors) for the 2005 to 2010 period per IT domain which are linked to the following constellations: “IT_CRM”, “IT_Fulfillment_Explore”, IT_Internal, IT_Inventory_Ethane, IT_Fulfillment_PILA or to an IT_Interco object when websphere related.

- **2533 Applic. SW WFMS**

The **WorkForce Capacity Management** tool (WFM) asset is composed of 23 applications which automate the dispatching on the field of all Belgacom's technicians including a scheduler and reporting system. This asset is linked exclusively to the IT_WFM constellation.

- **2534 Applic. SW UTS**

The **Unified Trouble Ticketing System** (UTS) is a system used in order to register and follow-up issues pro-actively and reactively. Two IT domains which separate large customers from the others: the A-ETS domain is mapped to the IT_Service_Assurance_LeasedLines constellation and the A-UTS Domain is mapped with the IT_Service_Assurance_Transport&Wholesale.

- **2535 Applic. SW Cust Relationship Management**

This asset is composed of two applications related to the selling process and are directly linked to the IT_CRM constellation: **Customer Sales Assistant** (CSA) and **Customer Value Management** (CVM).

- **2536 Appl SW COB**

This asset pools costs from the **Customer Oriented Billing** system (COB), composed of 24 applications that are mapped on 3 different domains: **Customer DataBase** (A-CDB Domain), **Intercarrier Billing Information System** (A-IBIS Domain) and the **Call Details Records Flow** (A-CDRFLOW domain). Capex mandays from 2005 to 2010 were used as keys to allocate this asset to each domain which are mapped accordingly to the following: A-CDB is linked to the IT_Billing constellation, A-IBIS to IT_Billing&Wholesale and A-CDRFLOW to IT_Billing_Retail&Wholesale. Billing data is a sensitive matter for both customers and Belgacom and requires real-time redundancy. Therefore, COB applications are hosted on dedicated technology: Tandem servers, also called "Non-stop servers".

- **2537 Appl SW SAP**

The SAP Asset pools all costs coming from the 11 modules used by SAP in Belgacom. Each module has an IT Domain assigned, helping in the allocation process since capex manpower is reported on IT domains. Capitalized mandays for the 2005 to 2010 period were used to split the costs per module which are mapped to a specific IT Constellation. For instance, the A-SAP CRM domain is sent to the IT_ERP_CRM⁷ constellation or A-SAP FIN to IT_ERP_FIN. This method helps the allocation process from constellations to activities as SAP modules are often used in a core-process such as SAP FIN used by Finance activities or SAP HR used by HR for their own processes.

- **2538 APPL SW-Number Portability**

Number Portability is composed of two domains called **Fixed Number Portability** (A-FNP) and **Carrier Pre-Selection** (A-CPS) and the asset cost will be split between these two domains using capitalized mandays key of the 2005 to 2010 period. CPS is an important system as it is an interface with olo's requirements to deliver their services. Therefore, the A-CPS domain will be mapped to a specific constellation named IT_Fulfillment_BRIO_CPS. As for A-FPS, it is a domain exclusively used by Belgacom and is linked to the IT_Fulfillment_NumberPortability constellation.

- **2539 Applic. SW ECA/ECM/VORTAL**

⁷ ERP is an acronym for **Enterprise Resource Planning** which is the generic term for SAP like programs

E-Channel Applications (ECA) and E-Content Management (ECM) are tools to manage and web-enable digital content for consumers (B2C) or enterprises (B2E). These are websites to engage customer relationship in order to conduct e-business via the Belgacom websites. 40 applications are stored in this asset and regrouped into 3 IT domains. They are all linked to the same constellation which is IT_CRM.

- **2540 APPL SW – ROSY**

ROSY (also called SALY) is a core component of the IT infrastructure as it is the runtime engine for SDH, XDSL and ITDV provisioning and repair. ROSY is one of the most complex systems in the company: 64 applications are grouped in this asset and then dispatched in 3 domains. Rosy being the main provisioning system, all costs are sent to the the IT_Fulfillment_PIA constellation.

- **2541 APPL SW – NETCAM**

NETCAM is a dedicated asset for Rosy's workflow engine for SDH (BPEL). All costs are directly sent to the SNM application which is the only application for Netcam.

- **2542 Sales Handling Engine(SHE)**

The Sales Handling Engine (SHE) is a sales application used as a layer in order to enable convergence between all selling applications so that our vendors and partners will have a global view on all products supplied by Belgacom Group, improving order intake and rationalizing the IT selling infrastructure. Pre-Sales and Sales are activities in the fulfillment process and such as SHE will be allocated to the IT_Fulfillment_PILA constellation.

- **2543 APPL SW OHE**

Asset that is nearly empty. All costs are directly sent to OHE (Order Handling Engine) application which has been replaced by OMS (order management system).

- **2544 APPL SW -IT Security**

IT Security asset pools heterogeneous costs that can be application related (NFM – New Fraud Management and IMS (Identify and authentify for provisioning engine) costs, building costs (physical security), Skynet Costs to protect user's privacy or overhead costs to protect the IT infrastructure from malicious harm (virus, pirate take-over etc.)

- **2545 SW Usability Lab**

This asset will follow the same allocation pattern as the 2509 HW Usability Lab and all costs will be sent to the IT_Overhead constellation.

- **2547 Major software applications**

Major software applications is an asset regrouping all new IT developments and applications since 2010.

- **2550 APPL SW ABC**

The Access Backbone Connectivity asset (ABC) is a core element of Belgacom's infrastructure. SRW is an inventory for connectivity and equipment documentation and is used as an interface between 3 IDMS Applications and front-office applications such as OMS, WFM or COB/CDB.

Three other core domains are also pooled in this asset: ABR⁸ for the local loop connectivity and managing resources and services. ANA⁹ (Automated Number Assignment) supports service order provisioning of phone numbers through automation of the attribution of a phone number to a customer. Finally, ITR¹⁰ (Infrastructure TRansmission) is the inventory of Belgacom's backbone and optical network covering leased lines, physical equipments, trails, trunks, cables and the multiplexing hierarchy between all these elements. The mapping with IT Constellations is as follows: A-SRW is linked to IT_Inventory_LocalLoop&Transmission, A-ABC-ABR to IT_Inventory_LocalLoop, A-ABC-ANA to IT_Inventory_PSTN/ISDN and A-ABC-ITR to IT_Inventory_Transmission.

It should be noted that applications grouped in this asset use a special hardware in order to run properly as they are all linked to huge databases that require daily processing of data per batches. For the last years, BS2000 mainframes from Fujitsu were used but they were recently replaced by Z-Series from IBM¹¹.

- **2551 Operational Inventories**

Operational Inventories are applications used to maintain ATM, DSLM, Ethernet and IP inventories and statistics. All applications and domains from this asset are pooled in the IT_Inventory_Data constellation.

- **2552 GraphDoc**

The Graphdoc asset pools all graphical documentation components which are tools used to create or modify the local loop network documentation. It allows an integration of the Autocad package which is a drawing software. All costs from applications and domains in this asset are allocated to a constellation called IT_Inventory_CableInfrastructure.

- **2561 APPL SW – NETCOOL**

Netcool is a software package sold by IBM and developed internally to suit Belgacom's needs. It is a set of alarms and probes used for monitoring to ensure both a pro-active and reactive service assurance process. It is divided in two main domains: Netcool Transmission (NCT) and Netcool Data (NCD). All domains from this asset are allocated to the IT_ServiceAssurance_Data&Transmission constellation.

- **2562 APPL SW - e-Health**

E-health is a reporting tool for bilan and is composed of 3 domains: e-health (A-EHT), Provisioning (A-PRO) which is an interface between e-health and umbrella/CMS and oblicore service layer (A-SLR). These domains are allocated to the service assurance of Explore products.

- **2563 APPL SW-Customer Remote Support**

Applications used by the helpdesks or to customers through the belgacom portal. Related costs are allocated to the IT_ServiceAssurance constellation.

⁸ Key figures : more than 5000 users and 2000 orders treated per day

⁹ Key figures : more than 5000 users

¹⁰ Key figures : more than 2000 users

¹¹ One IBM z10 Mainframe is supposedly 1500 times more powerful than regular x86 servers while consuming 85% less power (source IBM).

- **2566 APPL SW-DIAMON&CORRELATOR**

The diamond (DIA) and Correlator (CRL) asset regroups those two IT domains that enable the monitoring of network alarms. It also creates tickets to respond efficiently to problems. All costs from this asset end up in the IT_ServiceAssurance_Data&Transmission constellation.

- **2567 APPL SW – DARE**

DARE stands for **Diagnose Analyze Repair Engine** and is the main tool to analyze alarms and probes reports. It diagnoses problems through a root analysis, classifies incident by priority and forwards them to responsible persons for problem resolution.

- **2568 APPL SW-Learning & Mngt Syst.**

The learning management system asset is essentially a component of SAP HR (or SAP LMS for **Learning Management System**) which is linked to the IT_ERP_HR constellation as it is an extension from that module.

- **2569 APPL SW-ECRM**

The E-CRM asset contains one application named **Group Content Management (GCM)** which is a platform for contract, records and business process management. It is linked to the IT_CRM Constellation.

- **2570 APPL SW Business Intelligence Tool**

All costs from the Microstrategy software are sent to the Business Intelligence Tool asset as the main software used by our business intelligence department (which is the Data Warehouse: DWH). It is heavily related to data warehouse and will be grouped with it so that the tools they use are represented in the total cost of the data warehouse.

- **2571 APPL SW ONE-Catalog**

Asset pooling costs from the Belgacom **Product Catalog (BPC)** which is an application that stores advice and information about all products and services.

- **2573 Appl SW DWH**

The data warehouse department has heavy requirements in terms of hardware and software as it calculates statistics and indicators for Belgacom's products and network. A dedicated IT constellation has been created in order to pool costs from the data warehouse: IT_Business_Intelligence. Data warehouse uses a special hardware from the Teradata technology that helps with the treatment of large data volumes with the possibility for many users to analyze them.

- **4403 Midrange SW**

Old Asset waiting to be liquidated.

- **4470 TELANET HW**

Old asset waiting to be liquidated.

- **1724 Network Management-SW-Configuration&Routing Manag.**

Old asset treated as overhead.

- **1731 TMN-Trouble ticketing&fault management (Netcool,.)**

Old asset treated as overhead.

6.1.4.2 Operational Costs:

In order to allocate operational costs, the methodology followed is different from the one used for Capex ones.

Operational costs are extracted from SAP by Finance and are reported by cost centers. As they may regroup employees working on different tasks, as well as using a structure that may not be close to reality in all cases following the integration of Belgacom's subsidiaries, a functional approach was adopted in order to match the field's reality of the SDE division. This introduces the concept of Functional Domains, an acronym created for each level 3 team, which is generally a deep enough level to know precisely what is done by these teams. The mapping between cost centers and functional domains was done by Finance with the RAPID team, as it used to reports mandays to the system in a functional way. It was adapted by the Regulatory team in order to give more consistency to the data in aggregating some functional domains, or splitting them further more when needed (for instance: the monitoring department is shared by the IT monitoring team and the network monitoring team). RAPID reports mandays per functional domains and cost centers with details regarding which IT or Network objects are impacted. All Opex mandays from Belgacom employees reported in RAPID for 2010 will be used as keys to distribute costs per IT domains. The first step is to split the functional domains by type: they can be IT or Network related. The following explanations will only cover those that are IT related (see part "5.3 Allocation of Teamgroups to activities" and "7.9 Allocation of Network and **customer-related activities**" for network functional domains). There are 25 functional domains reporting costs in the IT sub-model.

Maintenance Costs is the other source of operational costs. A report provided by the department managing maintenance contracts was used to map all costs to an IT object in the model. Maintenance can be related to server's maintenance as well as applications.

6.1.5 Applications to Constellations

a) IT Applications

The IT applicative layer is composed of applications or software being used by either an end-user (such as an employee or a customer) or by a service (such as an inventory or a billing system). There are more than 1000 applications that have been bought off a vendor and adapted to suit the company's needs or developed internally by Belgacom's IT developers. Over the years, these applications have been updated, replaced, renamed or outphased. Applications and their

dependencies are reported in CMDB inventory with their acronym, their fullname and their description, allowing us to link them to constellations.

b) IT Domains

IT Domains are created by IT engineering and is a helpful means to both report IT manhours and to regroup IT applications into functional blocks. In terms of reporting, RAPID assigns reported hours to an IT domain instead of an application. This stage is therefore essential to the allocation of OPEX IT manhours. IT Domain naming convention is A-xxx where xxx is a 3-letter acronym from the main application. For mobile applications, no prefix exists.

c) IT Constellations

IT Constellations are a creation of the IT sub-model: it is the bridge between the sub-model and the ABC products: a concatenation of process as defined in the regulatory model (such as fulfillment or service assurance) with a set of products (such as ADSL/PSTN or Leased Lines). The following constellations were created in order to group all IT costs in an end-object.

For each of them, a specific allocation key is used in order to allocate costs to ABC products as recapped in the following table.

6.2 Allocation of IT constellations

IT constellations are allocated to end products using a variety of drivers listed below:

- (de)provisioning volume
- fair split
- Access Provisioning Volume
- Already allocated server CAPEX costs
- Number of dispatch units
- Amount of allocated CAPEX cost per technology group
- Amount of allocated Wages costs
- Mobile Usage Volume (Minutes and Data equivalent minutes)
- number of call (internal, external, freephone all included)
- number of subscriptions
- Revenue
- Nbr of subscriptions
- Total number of minutes

7 Network stream

The network allocation stream is organized around the network investment structure (leading to network functional blocks in the allocation stream).. The focus is on Capital Expenditure costs which are directly associated with the network equipment deployed ; these costs originate from the assets accounting system of Belgacom and they are gradually cascaded by means of a variety of cost deaggregation keys and a variety of cost drivers up to the telecommunication services. By contrast, the SRW stream focuses on the operating expenditures of the business activities, which are directly allocated to end-products by means of business drivers.

For the operating costs of the network itself however, an intermediate allocation approach is used : the remuneration costs and the personnel related OPEX costs are associated to typical network activities (as described in section 5.1 and in section 5.2) which are finally attributed to network functional blocks . This part is discussed in section 7.3 hereafter .

7.1 A layered allocation model

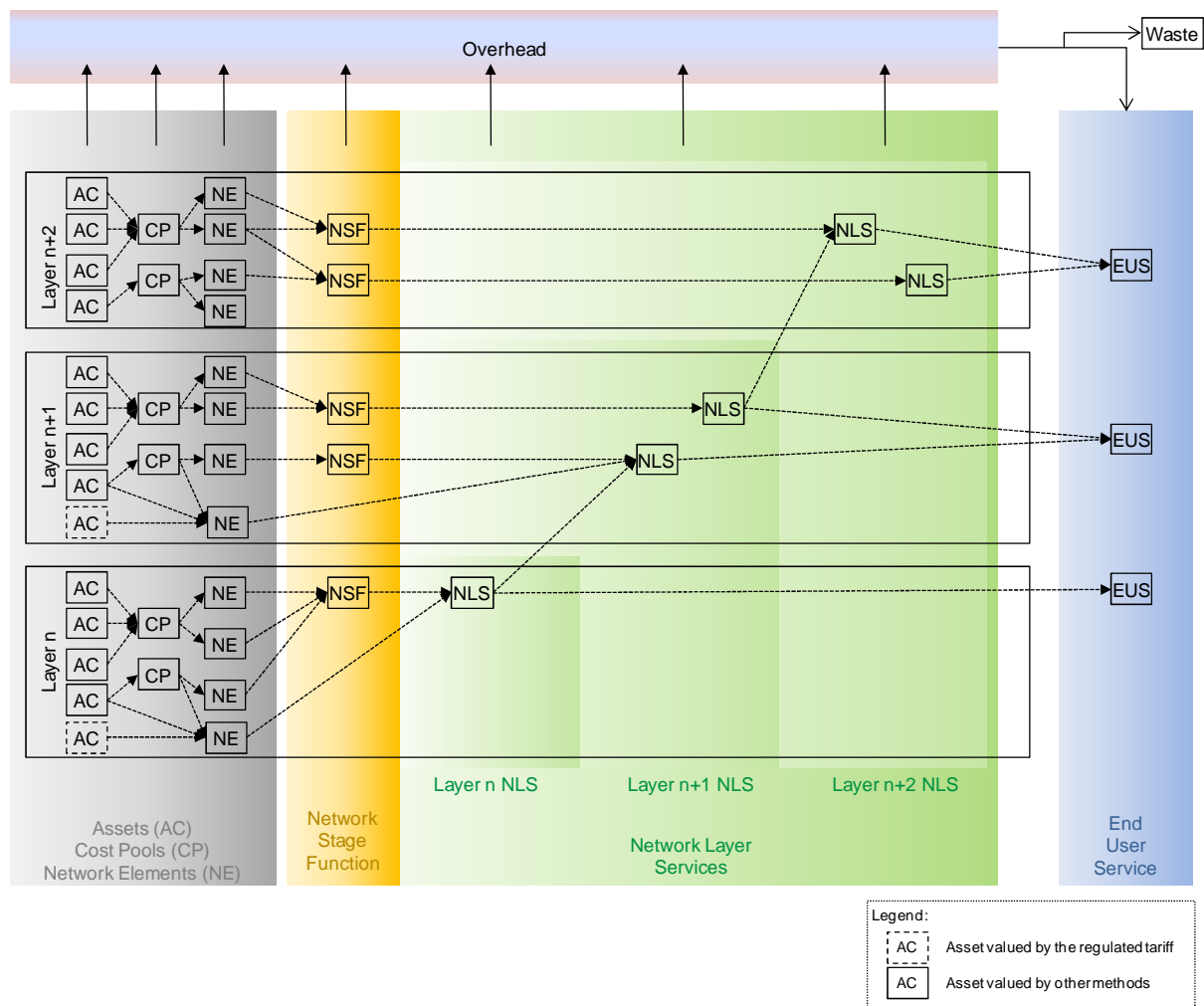

Figure 16 - Layered allocation model

It is common practice in the telecommunication industry to separate investments in different logical levels , lower levels corresponding to basic (simple and general purpose) services, higher

levels corresponding to complex higher valued and purpose oriented services. The pursued effect of such separation is to promote the reuse of basic lower level services by higher level services thereby bringing in the short term the volumes at each layer to levels that benefit from economies of scale. In the long term, the pursued effect is to benefit also from economies of scope.

The network cost allocation model is designed to reflect the layered functional structure of Belgacom's telecommunication infrastructure, each layer offering services to the upper layers. In practice, 5 layer levels are represented in the cost allocation model in order to allow each invested technology to be situated at the right level of its contribution in implementing the layer services.

In practice, a network equipment may participate to several different layers especially in the interfacing boards towards other network equipment because it acts as a terminating point of lower level layer services; for example an IP router interface typically implements ATM specification (for the ATM Virtual Circuits terminating in the equipment) as well as SDH specification (for the termination of Virtual Containers transporting ATM Virtual Circuits).

To avoid any ambiguity, a network equipment will be considered as belonging to the highest layer implemented in it and operated by it. For the example of the IP router, this simple criterium locates an IP router on the third layer (IP layer) above ATM and SDH.

Using this criterium all investments still in service of Belgacom's infrastructure are distributed in one of the following layers:

Layer NLS1.0 : Passive infrastructure gathering investments in access copper, in ducts and fibre cables (access and backbone).

Layer NLS2.0 : Active transmission infrastructure based on Time Division Multiplexing technology gathering investments in PDH, SDH.

Layer NLS2.1 : Active data infrastructure based on Packet Based technology gathering investments in ATM, Ethernet/MPLS.

Layer NLS3 : Active data infrastructure based on IP technology gathering IP routers, IPVPN routers.

Layer NLS4.0 : Active application infrastructure based on a variety of technologies gathering applicative equipment like telephony digital switches, VoIP platforms, Intelligent Network platforms, Broadcast TV platforms, Video on Demand platforms.

In the model layers are represented by a number of "standard" services (referred to in the sequel as Network Layer Services – NLS) offered to upper layers or directly used as retail/wholesale products (End User Services – EUS). In turn the services offered by a layer are the result of the combination of layer specific functions (referred to as Network Stage functions – NSF)* and services offered by lower level layers allowing the layer specific functions to interact with each other.

*Note: Except the following Network Elements that receive assets cost valued by the regulated tariff. Those Network Elements include network stage functionality and directly offer services of the same level as their's or upper layer services. The driver used is "yearly direct CAPEX cost". The driver "yearly direct CAPEX cost" is in fact a by-product of the valuation exercise done for the assets valued by the regulated BIPT tariff.

For the asset valuation exercise a full integration of all the asset valuation components of the relevant technology was necessary (see paragraph 3.4.2.6.4), but in the case of the calculation of this driver the required aggregation degree is determined by the allocation key to be calculated.

The inventories used as input for the asset valuation contain many details allowing the grouping of the costs components based on any combination of such aspects.

Therefore, the driver “yearly direct CAPEX cost” refers to the sum of all the relevant technology valuation components from the appropriate models that meet the allocation requirements (for example, usage of the link or bandwidth or bandwidth and service span or concerned network layer...).

NE receiving assets valued by the regulated tariff	offered services
NE_(D)WDM equipment	NLS2_0_InterCityBackboneCapacity<2M NLS2_0_InterCityBackboneCapacity=2M NLS2_0_InterCityBackboneCapacity>2M NLS2_1_Backbone_MulticastVPLS_IntraRegion NLS2_1_Backbone_Pseudowire_InterCity NLS2_1_Backbone_UnicastVLAN_Transport_IntraRegion NLS2_1_Backbone_VirtualPath_InterArea NLS2_1_BackboneCapacity_Ethernet>=10M NLS2_1_InterCityBackboneCapacity_Ethernet>=10M NLS2_1_LocalTailCapacity_Ethernet>=10M
NE_Access fibre infrastructure	NLS1_0_Fibre_connect_to_the_office NLS2_1_VDSL_Bitstream
NE_ADSL equipment	NLS2_1_ADSL_SDSL_Bitstream
NE_ATM equipment	NLS2_1_Access_into_VirtualPath NLS2_1_Backbone_VirtualPath_IntraArea NLS2_1_Backbone_VirtualPath_Local
NE_Backbone fibre infrastructure	NLS2_0_InterCityBackboneCapacity<2M NLS2_0_InterCityBackboneCapacity=2M NLS2_0_InterCityBackboneCapacity>2M NLS2_0_IntraAreaBackboneCapacity<2M NLS2_0_IntraAreaBackboneCapacity=2M NLS2_0_IntraAreaBackboneCapacity>2M NLS2_0_IntrazonalBackboneCapacity<2M NLS2_0_IntrazonalBackboneCapacity=2M NLS2_0_IntrazonalBackboneCapacity>2M NLS2_0_LocalBackboneCapacity<2M NLS2_0_LocalBackboneCapacity=2M NLS2_0_LocalBackboneCapacity>2M NLS2_1_Backbone_MulticastVPLS_IntraRegion NLS2_1_Backbone_Pseudowire_InterCity NLS2_1_Backbone_UnicastVLAN_Transport_IntraRegion NLS2_1_Backbone_VirtualPath_InterArea NLS2_1_BackboneCapacity_Ethernet>=10M NLS2_1_InterCityBackboneCapacity_Ethernet>=10M
NE_Copper infrastructure	NLS1_0_Continue_Raw_Copper NLS1_0_Copper_Localloop_testing

	NLS1_0_Copper_Splitter
	NLS1_0_Copper_Subloop
	NLS1_0_Copper_Subloop_testing
	NLS1_0_Raw_Copper
NE_ethernet equipment	NLS2_1_Backbone_MulticastVPLS_IntraRegion
	NLS2_1_Backbone_Pseudowire_InterCity
	NLS2_1_Backbone_UnicastVLAN_Transport_IntraRegion
	NLS2_1_LocalTail_PrivateVLAN_transport_HighEnd
	NLS2_1_LocalTail_PrivateVLAN_transport_lowEnd
NE_NGA Active equipment	NLS2_1_VDSL_Bitstream
NE_NGA Housing	NLS2_1_VDSL_Bitstream
NE_PDH SDH equipment	NLS2_0_InterCityBackboneCapacity<2M
	NLS2_0_InterCityBackboneCapacity=2M
	NLS2_0_InterCityBackboneCapacity>2M
	NLS2_0_IntraAreaBackboneCapacity<2M
	NLS2_0_IntraAreaBackboneCapacity=2M
	NLS2_0_IntraAreaBackboneCapacity>2M
	NLS2_0_IntrazonalBackboneCapacity<2M
	NLS2_0_IntrazonalBackboneCapacity=2M
	NLS2_0_IntrazonalBackboneCapacity>2M
	NLS2_0_LocalBackboneCapacity<2M
	NLS2_0_LocalBackboneCapacity=2M
	NLS2_0_LocalBackboneCapacity>2M
	NLS2_0_LocalTail<2M
	NLS2_0_LocalTail=2M
	NLS2_0_LocalTail>2M
	NLS2_1_Backbone_VirtualPath_InterArea
	NLS2_1_BackboneCapacity_Ethernet>=10M
	NLS2_1_InterCityBackboneCapacity_Ethernet>=10M
	NLS2_1_LocalTailCapacity_Ethernet>=10M

Layer n--layer n+1 cost allocation mechanism:

Each layer represented in the model produces the defined NLS services with a certain amount of volume (the service amount); this amount is “consumed” by the upper layer services and it is used as a driver to allocate the costs to the consumer services in the upper layers.

Layer cost allocation cascade:

The 5 defined layers are put one after another according to their level generating a cascade of cost allocation mechanism.

Each layer is discussed in a specific chapter of this documentation.

Establishing costs of the Network Stage Functions

The “network stage functions” (NSF) are the direct constituents of a layer ,they are intermediate network building blocks providing well defined logical network functions specific to that layer (also called network functional units) . A Network Stage Function can be limited to a node or it can be a cluster (distributed function) corresponding to “network stages”. A network stage function is characterized by the amount of function it produces (volume).

Network Stage Functions are implemented in equipment , but the corresponding investment values are not always directly identifiable in the asset structure of Belgacom : for example some assets aggregate investments per technology (not per function in the network) , some other do not cover the totality of a given technology due to the history of the accounting asset structure in SAP (reorganization of assets, transfers between assets, closing of asset classes and opening of new ones) .

Different methods are used and combined to constitute the investment costs of Network Stage Functions :

1. Aggregation of assets in a larger asset or a cost pool in order to gather investments of same technology and align them with operational inventories.
2. Deaggregation of cost pools in network elements : this step decomposes cost pools into network elements; a network element corresponds to an entire physical equipment as deployed in the Belgacom infrastructure. Operational inventories of pieces of equipment and component prices are used.
3. Direct allocation of assets or cost pools to network elements when the assets or cost pools are directly identifiable with a network element of the model.
4. Composition of the network elements to form a network stage function covering one of the stages.

The stepwise combination of these methods are discussed in the next section.

7.2 From Assets to Network Stage Functions.

Next table gives the list of the 40 NSF present in the network allocation flow.

Layer	Layer Name	NSF_Name	NSF short description
Layer3	L3_IP	NSF_BroadBand_Public_IP_Collect	Access authentication , data traffic accounting, attribution of public IP address to broadband customers and collection of customer traffic towards public internet service providers
Layer3	L3_IP	NSF_BroadBand_VoD_IP_Collect	Access authentication , data traffic accounting, attribution of IP TV address to IP TV customers and collection of IP video customer traffic towards Video On Demand platforms
Layer3	L3_IP	NSF_BroadBand_VoIP_IP_Collect	Access authentication , data traffic accounting, attribution of Voice over IP address to VoIP customers and collection of Voice over IP customer traffic towards VoIP platforms
Layer3	L3_IP	NSF_Dedicated_Access_to_PrivateIP	
Layer3	L3_IP	NSF_PrivateIPSwitching	IP-VPN switching
Layer3	L3_IP	NSF_PublicInternetSwitching	Public Internet Routing
Layer3	L3_IP	NSF_IP_security	
Layer4	L4_IDTV	NSF_BroadcastTV	
Layer4	L4_IDTV	NSF_VoD	

Layer4	L4_VOICE	NSF_Advanced_Number_Translation_CallHandling	Voice Value Added network function destined to Business customers
Layer4	L4_VOICE	NSF_CallerIdentity_CallHandling	Voice Value Added network function destined to residential customers
Layer4	L4_VOICE	NSF_CallingCard_CallHandling	Voice Value Added network function destined to residential customers
Layer4	L4_VOICE	NSF_InteractiveVoiceResponse_CallHandling	Voice Value Added network function
Layer4	L4_VOICE	NSF_InternetDialUp_CallHandling	
Layer4	L4_VOICE	NSF_ISDN_Primary_Access	Access for PRA
Layer4	L4_VOICE	NSF_ISDN_Voice_concentrator	Aggregation of ISDN voice calls towards backbone circuit switching
Layer4	L4_VOICE	NSF_NumberPortability_CallHandling	telephony ported number realtime translation
Layer4	L4_VOICE	NSF_OtherAdvanced_CallHandling	Voice Value Added network function
Layer4	L4_VOICE	NSF_PrepaidCallingCard_CallHandling	Voice Value Added network function destined to residential customers
Layer4	L4_VOICE	NSF_PSTN_Voice_concentrator	Aggregation of PSTN voice calls towards backbone circuit switching
Layer4	L4_VOICE	NSF_Televoiting_CallHandling	Voice Value Added network function destined to Business customers
Layer4	L4_VOICE	NSF_VirtualPrivateNetwork_CallHandling	Voice Value Added network function destined to residential customers
Layer4	L4_VOICE	NSF_Voice_call_CAE_charging	generation of call detail records for interoperator voice traffic accounting
Layer4	L4_VOICE	NSF_Voice_call_CAE_Processing	handling of voice calls at transit level
Layer4	L4_VOICE	NSF_Voice_call_CAE_Trunks	multiplexing/demultiplexing voice circuits at transit level
Layer4	L4_VOICE	NSF_Voice_call_Local_charging	generation of call detail records for customer voice usage charging
Layer4	L4_VOICE	NSF_Voice_call_Local_Processing	handling of voice calls at originating or terminating level
Layer4	L4_VOICE	NSF_Voice_call_Local_Trunks	multiplexing/demultiplexing voice circuits generated/terminated
Layer4	L4_VOICE	NSF_WakeUp_CallHandling	Voice Value Added network function destined to residential customers
Layer4	L4_VOICE	NSF_MessageWaitingIndicator_Inserting	Voice Value Added network function destined to residential customers
Layer4	L4_VOICE	NSF_Service_Announcements_Playing	
Layer4	L4_VOICE	NSF_Automated_call_distribution	intelligent distribution of calls towards call center
Layer4	L4_VOICE	NSF_Voicemail&Messaging	Voice Value Added network function destined to residential customers
Layer4	L4_VOICE	NSF_VoiceFeatures_SelfManaging	Voice Value Added network function destined to residential customers
Layer4	L4_VOICE	NSF_Public_NumberPortability_Database	telephony ported number repository
Layer4	L4_VOICE	NSF_Payphones	
Layer4	L4_VOICE	NSF_ISDN_NetworkTermination	
Layer4	L4_VOICE	NSF_PairGainSystem	
Layer4	L4_VOICE	NSF_Mobile_RAN	Mobile Radio Access function destined to all Mobile voice products
Layer4	L4_VOICE	NSF_Mobile_BackBone	Mobile back bone function destined to all Mobile voice and data products

Investment costs of Belgacom SA assets are mapped to these NSF, except investments related with network administration, and some other that cannot be related to any current product or service. The exceptions are not filed into the network allocation cascade, but are allocated like an overhead cost (i.e. with no direct causality) to a range of End User Services (depending on the kind of overhead cost) proportionally to the cascaded costs on these EUS.

Mapping asset cost sources to Asset objects of the model AC2

There are 134 network assets (or network related sub-assets: part of asset 2523). Among those assets there are 9 assets which are valued by the regulated tariff. They are all 1-to-1 allocated to a homonymic AC2 object except for the 7 voice switching assets which are aggregated in AC2_Voice_Switching_Equipment.

Mapping AC2 objects to cost pools or Network elements

AC2 Aggregation.

At this stage 128 AC2 asset objects are aggregated into 18 cost pools, 38 network elements , 3 overhead objects and eventually 2 end user services (costs marginal end user services , or direct waste).

The aggregations into 18 cost pools serve to form technology pools for which operational inventories can be queried for various statistics that are further used to decompose into network elements. The technology pools typically are (D)WDM equipment, ATM equipment, Copper Cables, Broadband (ADSL/SDSL) equipment, SDH equipment , PDH equipment, Ethernet equipment etc.

The aggregation into 38 network elements concerns assets that are already a network element , and it serves also to gather assets that are individually more detailed than the definition of network elements and that can be easily associated to a network element . Typical examples are IP-VPN assets , broadcast TV assets, Analog Multiplexers, Metallic line testing assets etc.

AC2 Deaggregation.

By contrast, a set of 11 AC2 assets are decomposed (deaggregated) into 17 cost pools, 11 Network elements , 1 waste pool and 1 marginal end user service.

Among these, 8 assets collect investments on network administration (Hardware and software supervision platforms) and on value added services platforms (IN, messaging, voice mail etc.) ; they need to be decomposed into the network technologies they supervise and into the value added service categories.

⇒ The driver used is the “cumulatedInvestedAmount” per technology obtained after deep analysis of historical investment data (TM1 financial reporting tool).

One asset collects internal cabling within technical buildings and is decomposed essentially into the following cost pools CP_Backbone_Coax_cabling, CP_Backbone_Optical_cabling, CP_(D)WDM_equipment.

⇒ The driver used is the “Current annualized cost” of the cost pools , calculated from a diversity of constituent volumes and corresponding prices (coax/fibre cables, connectors, copper pair cables , cable ways,etc) . The main volumes are extracted from the infrastructure inventory database (ITR), other volumes are derived under assumptions.

The AC2_VoiceSwitching_Equipment asset is decomposed in the three main switching units forming the switched network topology : the Remote Units (acting principally as voice

concentrators), the Base units (providing call processing and local switching), and the Transit Units (providing transit switching).

⇒ The driver used is the “Nbr of equivalent lines” , a unit that is at the basis of the purchase contracts with the switches vendors where purchased switching Unit (Remote, Base, Transit) value is proportional to the equivalent lines installed per switching unit. The driver value is obtained from installed base reporting of the switched voice network.

Deaggregation of cost pools into network elements

In performing the previous steps 26 cost pools are introduced in the model. They are now deaggregated into 27 different Network Elements by means of following drivers:

ELEMENT	Driver Name	Deaggregated Network elements
CP_(D)WDM_equip ment	EstimatedValue_of_DWDM_Co mponent	electrical-optical_transponders, WDM customer premise equipment, optical multiplexer
CP_ATM_Equipment	Underlying AC Cost Composition	ATM backbone switching&backbone trunk, ATM access interfaces
CP_Backbone_Coax _cabling	Nbr_Connections	pre-allocated to all inside network elements using coax cabling
CP_Backbone_Optic al_cabling	Nbr_Connections	pre-allocated to all inside network elements using fibre cabling
CP_Copper_Burried _Cables&Splices	CalculatedCurrentValue_of_Und erlyingCopperAsset	distribution cables , feeding cables
CP_DSLAM	EstimatedValue_of_DSLAM_Co mponents	splitters, broadband aggregators, ATM/Ethernet aggregators
CP_Ducts&Manhole s	ActualizedInvestedValue_of_Duc ts	Ducts&Manholes for Next Generation Access, Ducts&Manholes for corporate/complex nodes in access
CP_EthernetMPLS_e quipment	EstimatedValue_of_EthernetMP LS_Component	Ethernet Ports, Ethernet/MPLS switches
CP_ETHLTE_Copper	Nbr_Equipment	
CP_IntelligentNetwo rk_Hardware	EstimatedValue_of_IN_HW_com ponents	Service Control Point hardware, Service ManagementPoint Hardware, CPU, RAM memory , Disk
CP_IPVPN equipme nt	direct	
CP_LTE140M_Optic al	Total_installed_bandwidth_capa city(Gbps)	
CP_LTE34M_Optical	Total_installed_bandwidth_capa city(Gbps)	
CP_Main_Distributi on_Frame	direct	
CP_Optical_Fibre_C ables	ActualizedInvestedValue_of_Fibr eCables	Fibre cables for Next Generation Access, Fibre Cables for corporate/complex nodes in access
CP_Optical_Frame	Nbr_fibres_installed	Access optical frame, backbone optical frame
CP_OSS_PDH	fair split	
CP_OSS_VoiceTraffi c	fair split	
CP_Remote_Optical _platform	EstimatedValue_of_ROP_Compo nents	Housing&powering, copper cabling, fibre cabling
CP_SDH	EstimatedValue_of_SDH_Compo nents	Add/Drop Multiplexers at customer sites, Add/Drop Multiplexers in backbone, Special configurations in digital cross-connects
CP_VDSL1	direct	
CP_VDSL2	EstimatedValue_of_VDSL2_com ponents	Host aggregators, VDSL2 central site aggregators
CP_VoiceDigital_Bas	%VendorCertifiedValue_of_Rem	Voice concentration elements, Originating/Terminating Voice call

eUnit	oteUnit_subcomponents	handling elements
CP_VoiceDigital_Re moteUnit	%VendorCertifiedValue_of_RemoteUnit_subcomponents	Voice concentration elements, Voice call handling elements
CP_VoiceDigital_Tra nsitUnit	%VendorCertifiedValue_of_RemoteUnit_subcomponents	Voice concentration elements, Transit Voice call handling elements
CP_fibre infrastructure	estimated stand alone CAPEX cost	Access fibre infrastructure elements, Backbone fibre infrastructure elements

From Network elements to Network Stage Functions

The previous steps populate the cost model with 36 Network Elements. In the next step , they are allocated to the 41 Network Stage Functions.

Among these, 36 network elements are directly embedded within Network Stage Function (either identical to a NSF or constituent of a NSF).

NE technology	Nbr NE in model	NSF technology	Nbr NSF
ALL	1	ALL	1
ATMÐERNET	1	UNSPECIFIED	1
IDTV	2	IDTV	2
IP	4	IP	3
MOBILE	7	MOBILE	7
VOICE	12	BVAS	1
		MVAS	4
		VOICE	4
Grand Total	27		23

The other 13 network elements need to be further decomposed either because they still aggregate a same function deployed in different network stages or because they still aggregate different functions delivering different volumes.

NE technology	Nbr NE in model	NSF technology	Nbr NSF
IP	4	IP	3
VAS	6	BVAS	18
		MVAS	42
		VAS	6
VOICE	12	BVAS	3
		MVAS	7
		VAS	1
		VOICE	11
VOIP	1	VOICE	2
Grand Total	23		93

The decomposition of network elements into network stage function is driven by a variety of cost drivers listed below per technology :

NE_technology	DriverName
IP	Total_tributary_capacity(Gbps)
VAS	perc_occupation_of_IN_hardware_by_services
VOICE	Invested_Amount Nbr_of_equivalenceInstalledLines RoutedMin VendorCertifiedValue_of_Originating_Terminating_CallHandling_subcomponents VendorCertifiedValue_of_Transit_CallHandling_subcomponents
VOIP	VoIP_call_handling_distribution_logical_Area
MOBILE	Direct

7.3 End User Services

The network allocation model terminates when all network stage functions (or NEs) have been allocated to network layer services and when network layer services have been combined into a user level telecommunication service , the End User Service.

The End User must be understood as the telecommunication service party that will pay for the service. In case of a retail service the user is identical to the service consumer (residential service) or to the service provider (business service) , in case of wholesale service , the user is in principle another licensed operator , or a network service provider.

Being composed of network layer services, End User Services may emanate from different levels of network layers since interconnection between network operators is being unbundled . For retail services , the end user telecommunication services may arise from different layers : the more a service is oriented for a specific usage the higher the level of network layers involved. For example IP services are less usage oriented than voice telephony, the latter being a layer 4 service, the former a layer 3 service.

The End User Services represented in the model are listed hereunder.

End User Service Layer	Market	End User Service Name
L1_passive	InterConnect	EUS_Raw copper subscription
		EUS_Shared pair subscription
L2_packetBased	InterConnect	EUS_BROBA_accessLine
		EUS_BROBA_EndUserLine subscription
		EUS_wholesale transport BROBA subscription
	retail	EUS_X25
	Wholesale	EUS_Ethernet_Backhaul

L2_TDM	InterConnect	EUS_BROTSOLL_segment<2M EUS_BROTSOLL_segment>2M EUS_BROTSOLL_segment2M	
	Retail&Wholesale	EUS_LL <2M subscription - International EUS_LL <2M subscription - National EUS_LL >2M subscription- National EUS_LL >2M subscription - International EUS_LL 2M subscription - International EUS_LL 2M subscription - National EUS_LL_Analog National Subscription - National	
	Wholesale	EUS_Bandwidth_Wholesale subscription EUS_LL <2M Transit EUS_LL >2M Transit EUS_LL 2M Transit EUS_Nat IC-Infra Wholesale subscription	
	Wholesale	EUS_Trans LAN subscription	
	L2_TDM&L1_ActiveAnalog L3_IP	retail	EUS_BGC Mobile_Roaming Out data EUS_DataManagedServices EUS_Mobile_Data national EUS_Public_IP_Extension_on_Symmetric
		Retail&Wholesale	EUS_FastInternet subscription EUS_Private_IP&Ethernet_on_asymmetric subscription - National EUS_Private_IP&Ethernet_on_backup EUS_Private_IP&Ethernet_on_international Subscription EUS_Private_IP&Ethernet_on_symmetric_HighEnd Subscription - National EUS_Private_IP&Ethernet_on_symmetric_lowEnd Subscription - National
		Wholesale	EUS_ADSL_Carrier_wholesale subscription EUS_Mobile_Roaming IN_Data EUS_SDSL_Carrier_wholesale subscription EUS_VDSL_Carrier_wholesale subscription
		retail	EUS_IDTV_subscription
		InterConnect	EUS_BGC Mobile_Incoming SMS international EUS_BGC Mobile_Incoming SMS national
	L4_iDTV L4_messaging	retail	EUS_Mobile_On net SMS EUS_Mobile_Outgoing SMS_international EUS_Mobile_Outgoing SMS_national
Wholesale		EUS_Mobile_Roaming IN_Originating_SMS EUS_Mobile_Roaming IN_Terminating_SMS	
L4_voice	InterConnect	EUS_BGC Fixed international traffic incoming EUS_BGC Fixed National Transit (M)OLO traffic EAA interconnection EUS_BGC Fixed National Transit (M)OLO traffic IAA interconnection EUS_BGC Fixed Outgoing International Freephone traffic EUS_BGC Mobile international traffic incoming EUS_BGC Mobile National outg. FOLO EUS_Carrier PreSelection IAA interconnection EUS_Carrier PreSelection local interconnection EUS_Consultel 090x Traffic - FOLO to BGC Fixed EUS_EAA interconnection - (M)FOLO to BGC Fixed EUS_Freephone Traffic - BGC fixed and Mobile to FOLO EUS_IAA interconnection - MOLO to BGC Fixed EUS_IAA interconnection - BGC Fixed to FOLO EUS_IAA interconnection - FOLO to BGC Fixed EUS_Incoming International Transit (M)OLO Traffic EUS_Interconnection BGC Mobile to MOLO EUS_Interconnection FOLO to BGC Mobile EUS_Interconnection MOLO to BGC Mobile	

	EUS_International Transit border to border
	EUS_international_switchingTrunk
	EUS_internet traffic - FOLO to BGC 0909/3 IAA
	EUS_Local interconnection - FOLO to BGC Fixed
	EUS_Number Portability access per line subscription
	EUS_Outgoing International Transit (M)OLO Traffic
	EUS_Voice_traffic_IAA_PointOfInterconnect subscription
	EUS_Voice_traffic_Local_PointOfInterconnect subscription
retail	EUS_BGC Mobile Outgoing to International Traffic
	EUS_BGC Mobile to BGC Fixed
	EUS_BGC Mobile to BGC Mobile
	EUS_BGC Mobile_Roaming Out Origination
	EUS_BGC Mobile_Roaming Out Termination
	EUS_BVAS Call & Conference - BGC fixed
	EUS_Consultel 090x Traffic - BGC Fixed&Mobile to FOLO
	EUS_Freephone Traffic - (M)FOLO to BGC
	EUS_MVAS - BGC Fixed
	EUS_OPS International Information Traffic - BGC
	EUS_OPS National Information Traffic - BGC
	EUS_Other_Traffic - BGC Fixed
	EUS_Payph operations - BGC Fixed
	EUS_Split Charging Traffic - BGC Fixed&Mobile to FOLO
	EUS_Universal Access Number Traffic - BGC Fixed&Mobile to FOLO
	EUS_Virtual Private Network Traffic- BGC fixed
Retail&Wholesale	EUS_BGC Fixed DCIA traffic
	EUS_BGC Fixed international traffic outgoing
	EUS_BGC Fixed interzonal traffic
	EUS_BGC Fixed local traffic
	EUS_BGC Fixed to BGC Mobile
	EUS_BGC Fixed zonal non local traffic
	EUS_Calling Card Postpaid Traffic - BGC Fixed
	EUS_Consultel 090x Traffic - BGC Fixed&Mobile to BGC
	EUS_EAA interconnection - BGC Fixed to FOLO
	EUS_EAA interconnection - BGC Fixed to MOLO
	EUS_Freephone Traffic - BGC Fixed&Mobile to BGC
	EUS_IAA interconnection - BGC Fixed to MOLO
	EUS_Incoming International Freephone Traffic (OLO+BGC mobile) to BGC
	EUS_ISDN-BA Access - subscription
	EUS_ISDN-PRA Access - subscription
	EUS_PSTN Access - subscription
	EUS_Split Charging Traffic - BGC Fixed&Mobile to BGC
	EUS_Universal Access Number Traffic - BGC Fixed&Mobile to BGC
Wholesale	EUS_Mobile_Roaming IN Origination
	EUS_Mobile_Roaming IN Termination
	EUS_Split Charging Traffic - FOLO to BGC Fixed
	EUS_Universal Access Number Traffic - FOLO to BGC Fixed

7.4 Network services of the passive infrastructure layer : NLS1.0

7.4.1 Definition

This layer deals with the physical end-to-end connectivity between customers and the Belgacom Office (access) and the physical connectivity inside the Belgacom Office between access equipment.

Access Physical connectivity services (see Figure 17):

- NLS1_o_Continue_Raw_Copper : internal cabling copper connectivity from Main Distribution Frame or broadband splitter equipment to other access active equipment like voice switches, leased lines access equipment, collocated access equipment (of other licensed operators).
- NLS1_o_Copper_Localloop_testing : inside copper connectivity and equipment required to perform remote testing of the copper loop.
- NLS1_o_Copper_Splitter : resources to split narrowband and broadband copper physical signal.
- NLS1_o_Copper_Subloop : end to end copper connectivity (copper pair) from the network termination point at the customer premises and a delivery point in the street (street cabinet).
- NLS1_o_Copper_Subloop_testing : outside and inside copper connectivity and equipment required to perform remote testing of the copper subloop.
- NLS1_o_Raw_Copper : end to end copper connectivity (copper pair) from the network termination point at the customer premises and the Central site.
- NLS1_o_Fibre_connect_to_the_office : end to end fibre optical connectivity between the central sites and corporate customers office buildings and Belgacom subtended optical nodes.

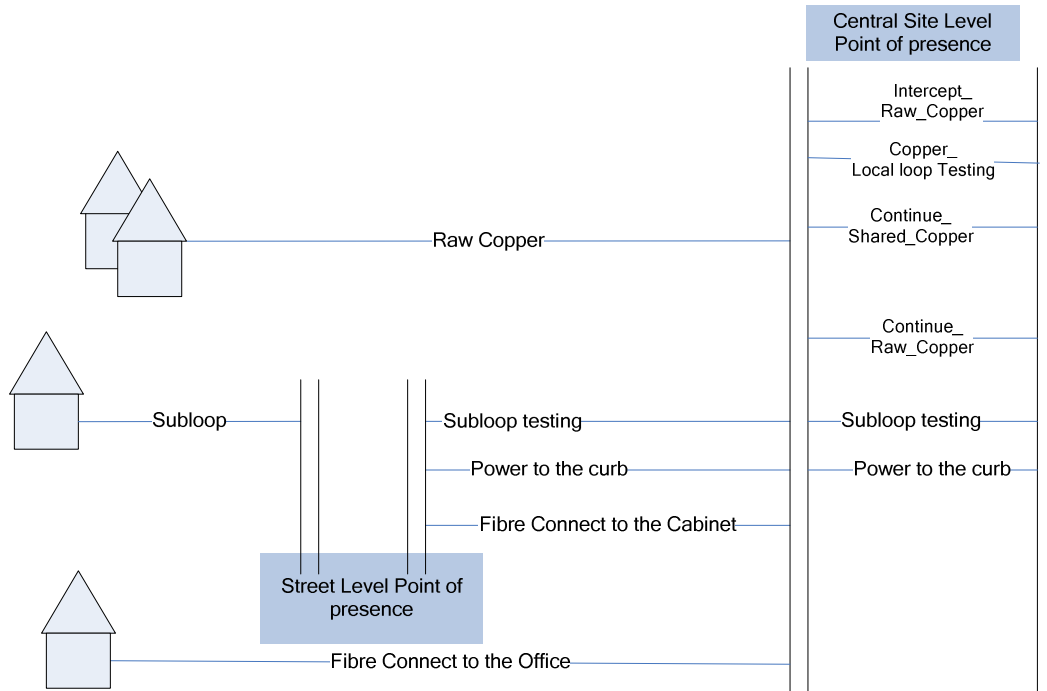

Figure 17

7.4.2 Usage of the passive infrastructure

The physical connectivity services of this layer are used by upper layers in order to interconnect their specific equipment. The costs are distributed to the service users according to “consumption drivers” as listed in the next table.

Network layer Service	Driver	Service consumers
<u>NLS1_0_Continue_Raw_Copper</u>	Nbr_of_used_pairs	BRUO raw copper, Local tails for leased linetype of connectivity, ISDN/PSTN accesses, BRUO Shared Pairs
<u>NLS1_0_Copper_Localloop_testing</u>	nbr of broadband lex based without voice	Broadband bitstream layer 2.1 services
<u>NLS1_0_Copper_Splitter</u>	Direct	BRUO Shared pairs
<u>NLS1_0_Copper_Subloop</u>	Direct	VDSL bistream layer 2.1 service
<u>NLS1_0_Copper_Subloop_testing</u>	Direct	VDSL bistream layer 2.1 service
<u>NLS1_0_Fibre_connect_to_the_office</u>	yearly direct CAPEX cost	Local tails services of layer 2.0 (for leased lines), of layer 2.1 (Ethernet local tails) and backbone services delivered by equipment located in subtended optical nodes.
<u>NLS1_0_Raw_Copper</u>	Nbr_of_used_pairs	BRUO raw copper, Local tails for leased linetype of connectivity, ISDN/PSTN accesses, Broadband Bitstream layer 2.1 service

7.4.3 Contributors to the passive infrastructure layer

The objective of the access network is the delivery of a connection between our customers and our telecommunication network where all services are implemented.

The related access network services of the passive infrastructure layer are based on :

- network element NE_Copper infrastructure

This network element includes copper assets that have been valued based on the regulated cost price :

- copper distribution pairs and access to distribution pairs in street (to be attributed to copper subloop for VDSL without voice connections and to the raw copper for all other copper connections, based on the corresponding regulated cost price);
- copper feeding pairs and access to feeding pairs in street (to be attributed to the copper subloop testing for VDSL without voice connections and to the raw copper for all other connections);
- access to copper pairs in technical building (to be attributed to the copper subloop testing for VDSL without voice connections, and to the raw copper for all other copper connections);
- continue feeding pairs in technical building for :
 - continue shared copper based on the number of shared pairs in service,
 - copper local loop testing for broadband without voice customers connections at the central site,
 - copper subloop testing for VDSL without voice customer connections at the street cabinet,
 - continue raw copper for all other copper pairs in use.
- network element NE_Access fibre infrastructure: contributing with the costs related to the high end accesses based on fiber technology.

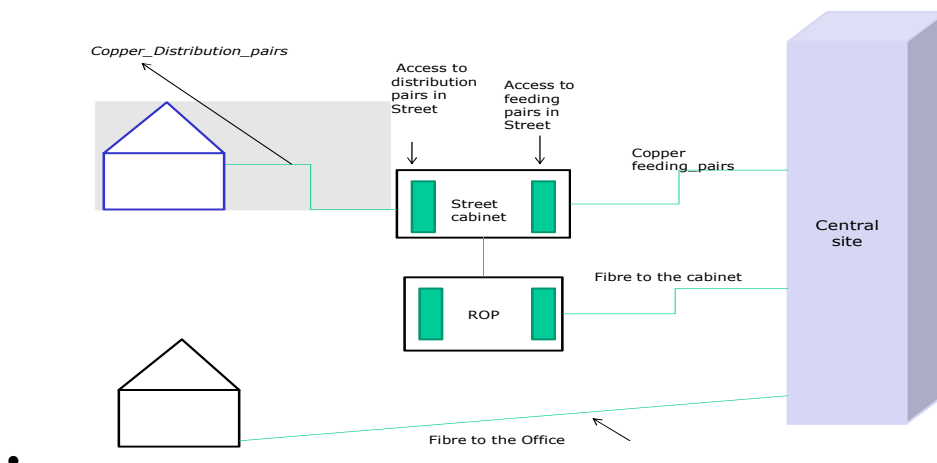

Figure 18

- *NSF_PSTN_Voice_concentrator*

attributed to :

- copper local loop testing based on the number of broadband without voice customers connections at the central site,
- copper subloop testing for VDSL without voice customer connections at the street cabinet,
- PSTN Access based on the number of subscriptions

Customer connections without voice are connected to the switching equipment in order to perform remote testing of the line (see figure 22)

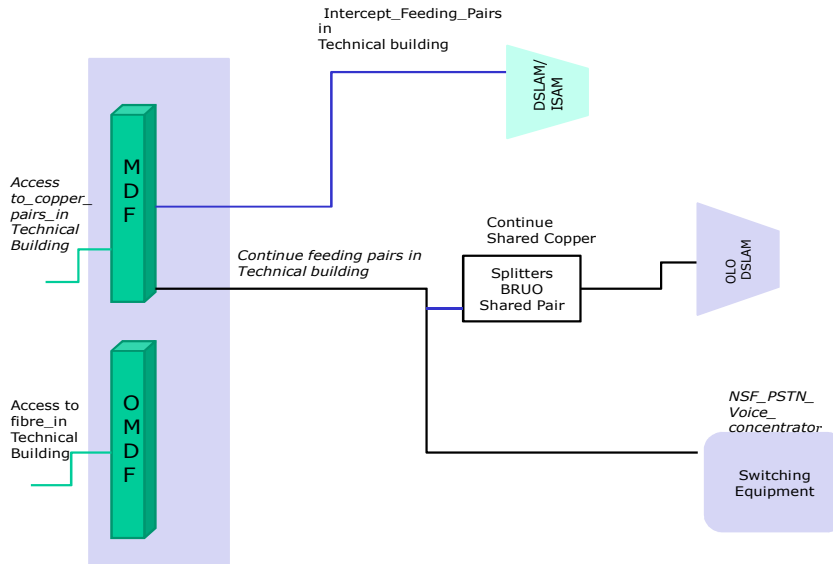

Figure 19

7.5 Network services of the transmission infrastructure (NLS2_0)

7.5.1 Definition

This layer deals with the transmission services between customer sites and the Belgacom Offices (access) also called local tail for leased lines, and it deals also with the transport segments services (also called backbone leased lines segments and backhaul capacity) between Belgacom Offices (backbone).

The national wide transmission infrastructure collects transmission traffic in three aggregation stages: local level aggregation (circ 600 locations), zonal level aggregation (circ 36 locations), area level aggregation (20 locations) (see Figure 20 - Transport Segments). Traffic at each stage can be crossconnected allowing to create transport segments from any location to any location.

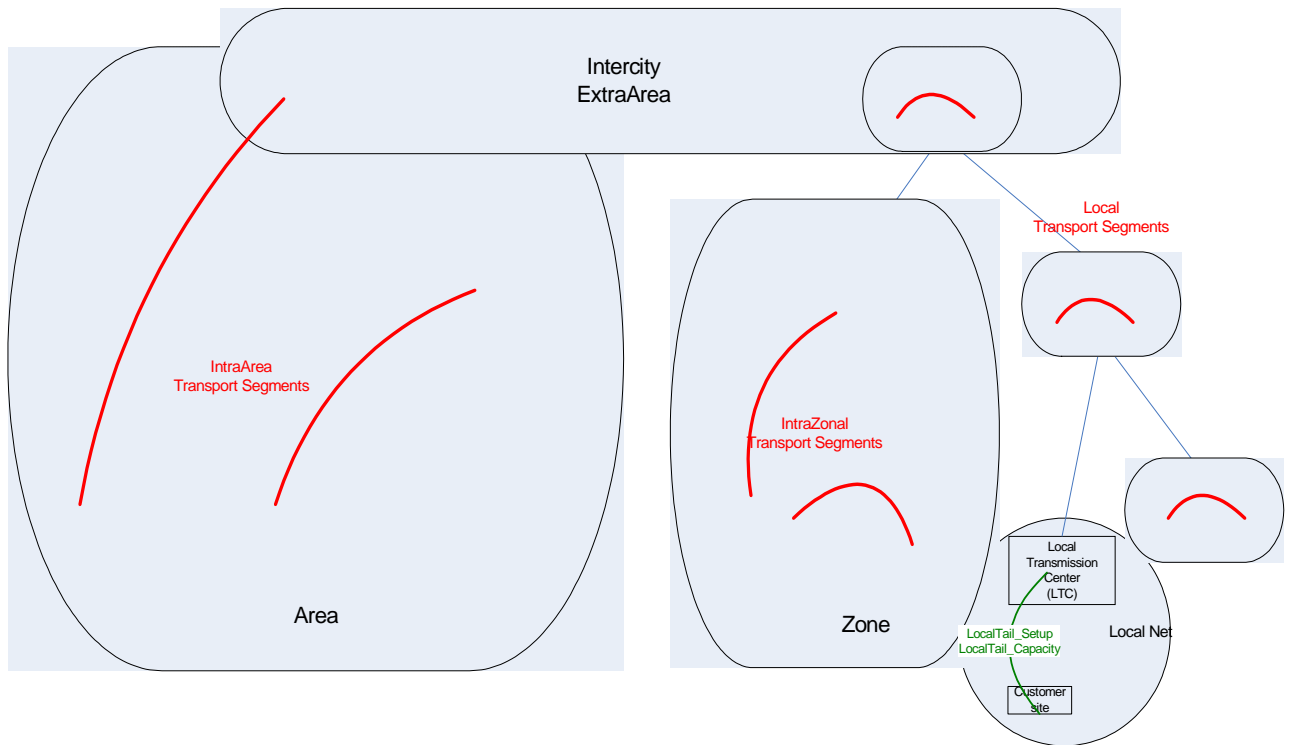

Figure 20 - Transport Segments

Access services

The access services deliver the transmission between the customer site and the Belgacom Office (access).

They capture costs related to the physical_dedicated link between the customer site and the central office and the equipment needed to activate the link in a capacity category.

Backbone services:

The backbone transport segments are classified in capacity (or bandwidth) categories -<2Mb/s, 2Mb/s, >2Mb/s- combined with distance categories -intraarea > intrazonal > local- depending on the end point situation in the aggregation hierarchy (see Figure 20 - Transport Segments).

The following NLS2.0 services are present in the model:

Network Layer 2.0 service
NLS2_0_LocalBackboneCapacity<2M
NLS2_0_LocalBackboneCapacity=2M
NLS2_0_LocalBackboneCapacity>2M
NLS2_0_IntrazonalBackboneCapacity<2M
NLS2_0_IntrazonalBackboneCapacity=2M
NLS2_0_IntrazonalBackboneCapacity>2M
NLS2_0_IntraAreaBackboneCapacity<2M

NLS2_0_IntraAreaBackboneCapacity=2M
NLS2_0_IntraAreaBackboneCapacity>2M
NLS2_0_InterCityBackboneCapacity<2M
NLS2_0_InterCityBackboneCapacity=2M
NLS2_0_InterCityBackboneCapacity>2M
NLS2_0_LocalTail<2M
NLS2_0_LocalTail=2M
NLS2_0_LocalTail>2M

7.5.2 Usage of the transmission infrastructure

The NLS2_0 Local tail services are used to bring transmission capacity to the customer sites and they are thus directly involved in leased line services between two customer sites, leased lines to data services, backhaul services to other licensed operators and monitoring of the access network.

The costs of these access services are distributed according to the number of customer sites per bandwidth category (driver name: "Nbr_of_Customer_sites"), whereas the backbone services costs are further allocated according to their bandwidth (driver name: "Bandwidth consumed (Mbit/s)").

The model elements receiving costs from this network layer are exhaustively presented in the following table.

	Upper layer consumer or end user service
Wholesale transport capacity	EUS_Bandwidth_Wholesale subscription
	EUS_Nat IC-Infra Wholesale subscription
Regulated wholesale segments	EUS_BROTSOLL_segment<2M
	EUS_BROTSOLL_segment>2M
	EUS_BROTSOLL_segment2M
Retail&Wholesale leased lines	EUS_International_switchingTrunk
	EUS_LL <2M subscription - International
	EUS_LL <2M subscription - National
	EUS_LL <2M Transit
	EUS_LL >2M subscription- National
	EUS_LL >2M subscription - International
	EUS_LL >2M Transit
	EUS_LL 2M subscription - International
	EUS_LL 2M subscription - National
	EUS_LL 2M Transit
	EUS_LL_Analog National Subscription - National
	EUS_Trans LAN subscription
	EUS_X25
Regulated broadband services	EUS_BROBA_accessLine
	NLS2_1_ADSL_SDSL_Bitstream
	NLS2_1_VDSL_Bitstream
Backbone Virtual Paths (VP)	NLS2_1_Backbone_VirtualPath_InterArea

	NLS2_1_Backbone_VirtualPath_IntraArea
Broadband access to public IP switching	EUS_FastInternet_subscription
	NLS3_ADSL_Public_IP_collection
	NLS3_VDSL_Public_IP_collection
Leased line access to public IP switching	NLS3_Public_IP_Extension_on_symmetric
Public IP switching	NLS3_Public_IP_switching
Leased line accesses to data services (IP-VPN)	NLS3_Private_IP&Ethernet_Extension_on_symmetric_HighEnd
	NLS3_Private_IP&Ethernet_Extension_on_symmetric_LowEnd
Ethernet access to data services (IP-VPN)	NLS2_1_LocalTail_PrivateVLAN_transport_HighEnd
International access to data services (IP-VPN)	EUS_Private_IP&Ethernet_on_international_Subscription
Data services backbone (IP-VPN)	NLS3_Private_IP&Ethernet_Routing
TV services	NLS4_0_BroadcastTV
	NLS4_0_VoD
Telephony access	NLS4_0_ISDN-PRA_access
Voice services in backbone	NLS4_0_RemotelyAggregatedVoice_transport
	NLS4_0_FixedSwitchedVoice_transport_National_offnet
	NLS4_0_SwitchedVoice_transport_CAE_CAE
	NLS4_0_SwitchedVoice_transport_CAE_MSC
	NLS4_0_SwitchedVoice_transport_LEX_CAE
	NLS4_0_SwitchedVoice_transport_LEX_MSC
	NLS4_1_Outgoing International Traffic - BGC Fixed
Belgacom mobile	NLS4_0_BGC Mobile_Access_Collect
	NLS4_0_BGC Mobile_Access_Distribute
	NLS4_0_BGC Mobile_BackBone
	NLS4_0_BGC MobileSwitchedVoice_transport_National_offnet
Monitoring lines	OVH_Management_Network
Belgacom testing environments	OVH_Lab
Other	BUSINESS OVERHEAD
	EUS_DataManagedServices
	EUS_Subsiaries

7.5.3 Contributors to the transmission infrastructure

7.5.3.1 Local Tail

A local tail transmission service is made of equipment installed at the customer premises extracting the digital signal from the physical line, of a physical link between the customer site and the central office and of grooming equipment in the central office (or subtended optical nodes).

Depending on the bandwidth of the local tail different equipment technologies are installed: PDH on copper , PDH on fibre or SDH on fibre. For the high bandwidth cases (>2Mb/s) a fibre based technology is required whereas for lower bandwidths the choice between fibre and copper

technologies exists. However, since fibre local links are much more expensive than copper links, the preferred option for low bandwidth local tails is the copper based solution.

	Contributor to NLS2_0	Driver name
Equipment	NE_PDH SDH equipment	yearly direct CAPEX cost
Physical inks	NLS1_0_Raw_Copper	Nbr_of_used_pairs
	NLS1_0_Continue_Raw_Copper	Nbr_of_used_pairs
	NLS1_0_Fibre_connect_to_the_office	yearly direct CAPEX cost

7.5.3.2 Transport Segments

Transport segments are realised by configuring the SDH clusters in different network stages. The transmission aggregation levels introduced hereabove (section 7.5.1 and Figure 20 - Transport Segments) are realised by different SDH clusters (regional, core and express SDH rings) interconnected by digital-crossconnects. The SDH rings are made of add-drop multiplexers deployed in LTC for the regional ones, in ZTC for the core ones and in the XTC for the express ones. The equipments within a ring are linked by fibre or by an optical wavelength.

To summarize ,the building blocks for the transport segments are:

Contributor to NLS2_0	Driver name
NE_fibre infrastructure	yearly direct CAPEX cost
NE_(D)WDM equipment	yearly direct CAPEX cost
NE_PDH SDH equipment	yearly direct CAPEX cost

7.6 Network services of the packet based infrastructure (NLS2_1)

7.6.1 Definition

This layer deals with the data collection services (broadband or dedicated) between the customer and the central office (access) and the transport of data central office (backbone) . Two technologies coexist as well in the access part as in the backbone part : ATM technology and Ethernet/MPLS technology. Next picture summarizes the end point locations of packet based services.

This layer also integrates point to point dedicated Ethernet transparent connections also named BLES services (Belgacom LAN Extension Service).

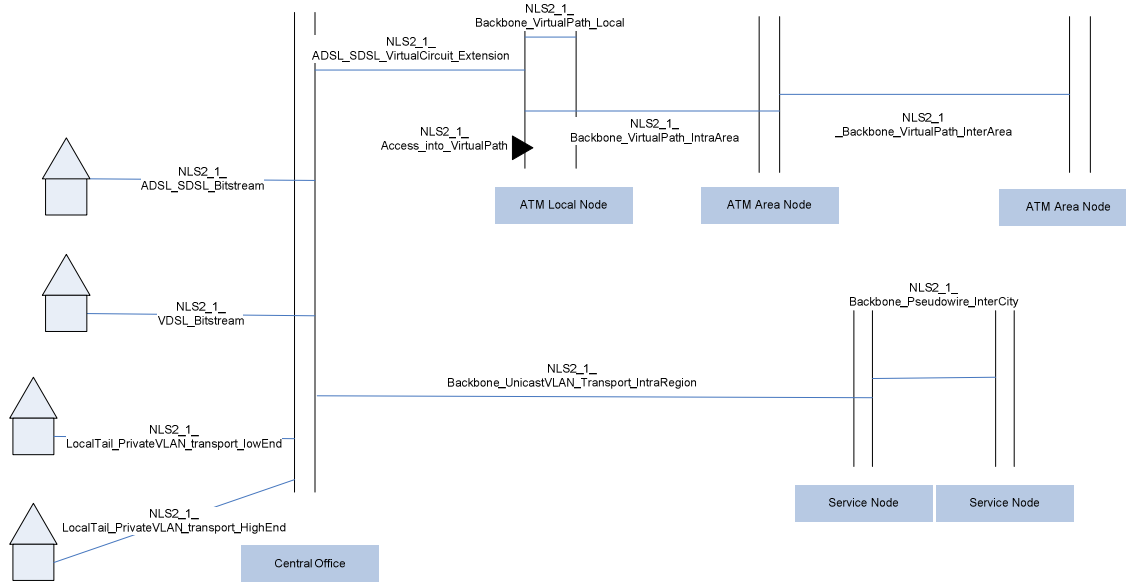

Figure 21

Access part

Layer 2.1 access service	Comment
NLS2_1_ADSL_SDSL_Bitstream	Broadband (ADSL-SDSL) end to end data streams between customer site and aggregation point in central office
NLS2_1_VDSL_Bitstream	Broadband VDSL end to end data streams between customer site and aggregation point in central office
NLS2_1_LocalTail_PrivateVLAN_transport_lowEnd	Ethernet symmetric dedicated link with central office over copper
NLS2_1_LocalTail_PrivateVLAN_transport_HighEnd	Ethernet symmetric dedicated link with central office over fibre
NLS2_1_LocalTailCapacity_Ethernet>=10M	High bandwidth transparent Ethernet frame transport between customer and central office (BLES local tail)

Backbone part

For data transport between central offices, the end point locations of the layer 2.1 services depend on the technology, the underlying networks having different topologies.

For ATM technology , the following services are defined:

Layer 2.1 ATM transport service	Comment
NLS2_1_Backbone_VirtualPath_Local	Transport of virtual circuits in a same ATM path in ATM local point of presence
NLS2_1_Backbone_VirtualPath_IntraArea	Transport of virtual circuits in a same ATM path from an ATM local point of presence up to the area level point of presence
NLS2_1_Backbone_VirtualPath_	Transport of virtual circuits in a same ATM path between 2 ATM area level point of presence.

InterArea	
NLS2_1_Access_into_VirtualPath	Direct access to a virtual path , allows to inject/eject ATM virtual circuits in/out of a transport virtual path

For the Ethernet/MPLS technology , the following services are defined:

Layer 2.1 Ethernet transport service	Comment
NLS2_1_Backbone_UnicastVLAN_Transport_IntraRegion	MPLS Transport of Ethernet VLANs between a central office and the service node of the region. These VLANs are unicast
NLS2_1_Backbone_Pseudowire_InterCity	MPLS Transport of Ethernet VLANs between service nodes of different regions. These VLANs are unicast
NLS2_1_Backbone_MulticastVPLS_IntraRegion	

Eventually , the dedicated Ethernet transparent connections (BLES service) also introduce backbone connectivity services :

Layer 2.1 Ethernet transparent transport	Comment
NLS2_1_BackboneCapacity_Ethernet>=10M	Any combination of end points different that of the two of them being express transmission centers
NLS2_1_InterCityBackboneCapacity_Ethernet>=10M	End points are between two express transmission centers

7.6.2 Usage of the data packet infrastructure

The access services of the data packet infrastructure are combined with the data packet backbone services to deliver end-to-end connectivity between IP appliances at customer site (IP router in ADSL/VDSL modems, private LAN IP routers) and IP service nodes , primarily the broadband access servers and the IPVPN routers offering layer3 services like ADSL/SDSL IP collection, VoD IP collection, Private VLAN extensions up to IPVPN nodes.

Next table summarizes the drivers used expressing how NLS2.1 contribute in layer 3 services or directly to End user services.

NLS2.1 service	Driver Name	Upper layer services "consuming" NLS2.1 services
NLS2_1_ADSL_SDSL_Bitstream	Nbr_of_used_xDSL_BROBA_lines	BROBA end user line, all broadband IP collections (public internet, VoD, VoIP), and broadband access to IP VPN
NLS2_1_VDSL_Bitstream	Nbr_of_used_VDSL_lines	all broadband IP collections (public internet, VoD, VoIP), and broadband access to IP VPN
NLS2_1_Access_into_VirtualPath	Configured_Bandwidth(Gbps)	Symmetric accesses to IPVPN
NLS2_1_Backbone_MulticastVPLS_IntraRegion	direct	For television

NLS2_1_Backbone_Pseudowire_InterCity	TotalPeakBandwidth_used(Gbps)	Broadband public IP NLS3 service, VoIP , Broadcast TV, and private IPVPN routing
NLS2_1_Backbone_UnicastVLAN_Transport_IntraRegion	EthanePeakHour PeakBandwidth_used(Mbps)	Broadband public IP NLS3 service, VoIP , VoD and access to private IPVPN routing and Ethernet backhaul
NLS2_1_Backbone_VirtualPath_InterArea	VP bandwidth Gbps	
NLS2_1_Backbone_VirtualPath_IntraArea	VP equivalent bandwidth Gbps (Topological efficiency and QoS aspects are translated in bandwidth +or- committed bandwidth)	BROBA transport, Broadband public IP NLS3 service, VoIP , VoD and access to private IPVPN routing
NLS2_1_Backbone_VirtualPath_Local	VP equivalent bandwidth Gbps (Topological efficiency and QoS aspects are translated in bandwidth +or- committed bandwidth)	BROBA transport, Broadband public IP NLS3 service, VoIP , VoD and access to private IPVPN routing
NLS2_1_InterCityBackboneCapacity_Ethernet>=10M	Bandwidth consumed (Mbit/s)	BLES EUS services, High capacity accesses to IPVPN, IP-VPN routers interconnection, internal networks routers interconnction
NLS2_1_BackboneCapacity_Ethernet>=10M	Bandwidth consumed (Mbit/s)	
NLS2_1_LocalTailCapacity_Ethernet>=10M	Bandwidth consumed (Mbit/s)	
NLS2_1_LocalTail_PrivateVLAN_transport_HighEnd	direct	Access to IPVPN layer 3 services
NLS2_1_LocalTail_PrivateVLAN_transport_lowEnd	direct	Access to IPVPN layer 3 services

7.6.3 Contributors to the data packet infrastructure services

The ATM based layer2.1 services are implemented by the configuration of the ATM network elements) interacting with each other using lower layer connectivity services (see picture Figure 22 - ATM based layer 2.1).

NLS2_1 ADSL SDSL Bitstream is the result of the central office (the Belgacom technical building closest to the end customer) based network element **NE_ADSL equipment**.

That function interacts with the broadband CPE equipment (at the customer site) by means of copper connectivity **NLS1_0_Raw_Copper** and **NLS1_0_Copper_Localloop_testing** (for the monitoring of copper line).

NLS2_1 Backbone VirtualPath IntraArea is the result of **network element NE_ATM equipment function** to inject the collected traffic into ATM VP , followed by the **regional transport function implemented in the ATM switching units and ATM backbone interfaces**.

The switching units interact with each other using lower level layer connectivity services: NLS2_0_IntraAreaBackboneCapacity>2M, NLS2_0_IntraZonalBackboneCapacity<2M, NLS2_0_IntraZonalBackboneCapacity=2M, NLS2_0_IntraZonalBackboneCapacity>2M, NLS2_0_LocalBackboneCapacity<2M, NLS2_0_LocalBackboneCapacity>2M

NLS2_1 Backbone VirtualPath Local is the result of network element NE_ATM equipment function to inject the collected traffic into ATM VP, followed by the regional transport function implemented in the ATM switching units (no backbone interface as VP remains local in the ATM equipment).

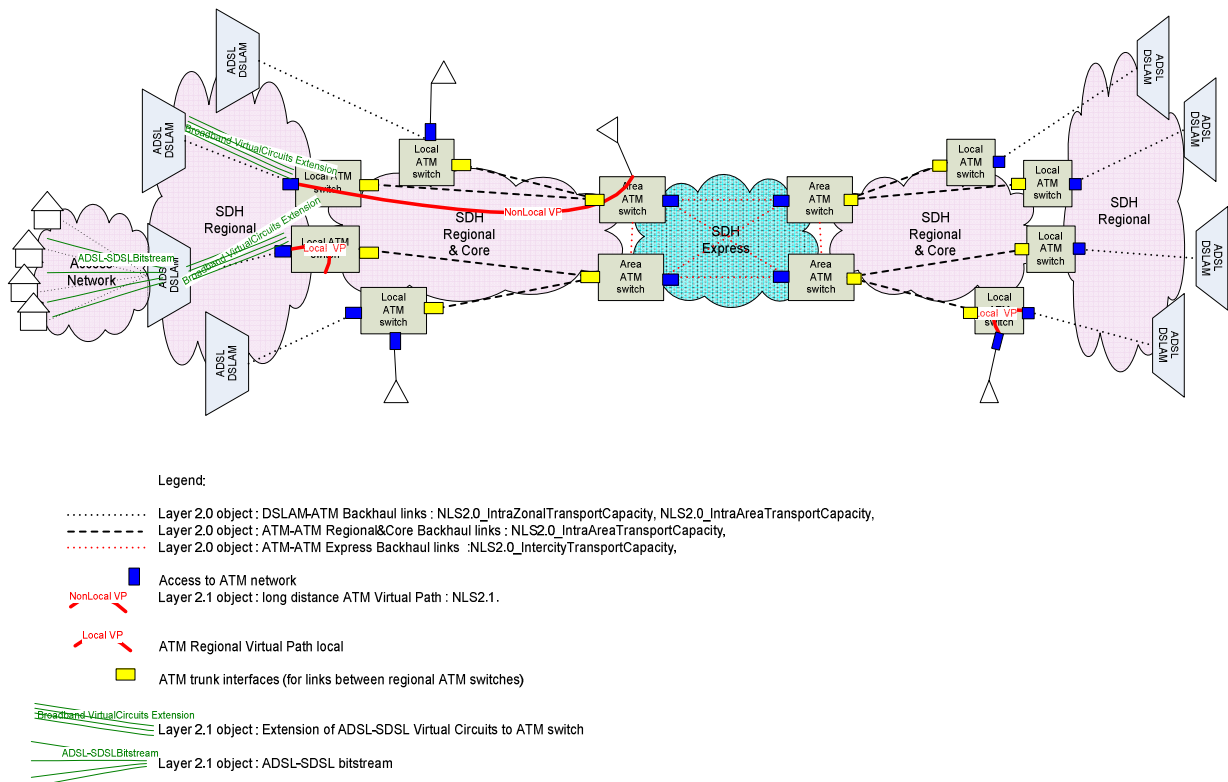

Figure 22 - ATM based layer 2.1

The Ethernet based layer 2.1 services are implemented by the configuration of the Ethernet/MPLS network elements (NE_ethernet equipment) interacting with each other using lower layer connectivity services (see picture Figure 23 - Ethernet layer 2.1).

NLS2_1 VDSL Bitstream is the result of the function present in the deployed VDSL equipment (network elements NE_NGA Active equipment and NE_NGA Housing).

That function interacts with the broadband CPE equipment (at the customer site) by means of copper and fibre connectivity NLS1_0_Raw_Copper, NLS1_0_Copper_Localloop_testing and NLS1_0_Copper_Subloop

_testing (for the monitoring of copper line), NLS1_0_Copper_Subloop, NLS1_0_Fibre_connect_to_the_office (for subtended optical nodes), NE_Access fibre infrastructure

NLS2_1 Backbone UnicastVLAN Transport IntraRegion is the result of the Ethernet/MPLS unicast function present in the deployed Ethernet equipment (NE_ethernet equipment). The function is activated in different locations to form aggregation clusters, whose links are mainly deployed on DWDM (NE_(D)WDM equipment over NE_fibre infrastructure) and in a limited number by direct fibre connectivity (NE_fibre infrastructure). The NLS2_1 Backbone Pseudowire InterCity and the NLS2_1 Backbone MulticastVPLS IntraRegion are implemented in the exact same way.

NLS2_1 LocalTail PrivateVLAN transport HighEnd and LowEnd are the result of customer sited equipment (NE_ethernet equipment) and the connectivity to the Belgacom network. Such connectivity consists of a fibre based link for the high end cases (delivered by the lower layer services NLS1_0_Fibre_connect_to_the_office) and of a copper based link in the low end situation (supported by the NLS1_0_Raw_Copper and NLS1_0_Continue_Raw_Copper services).

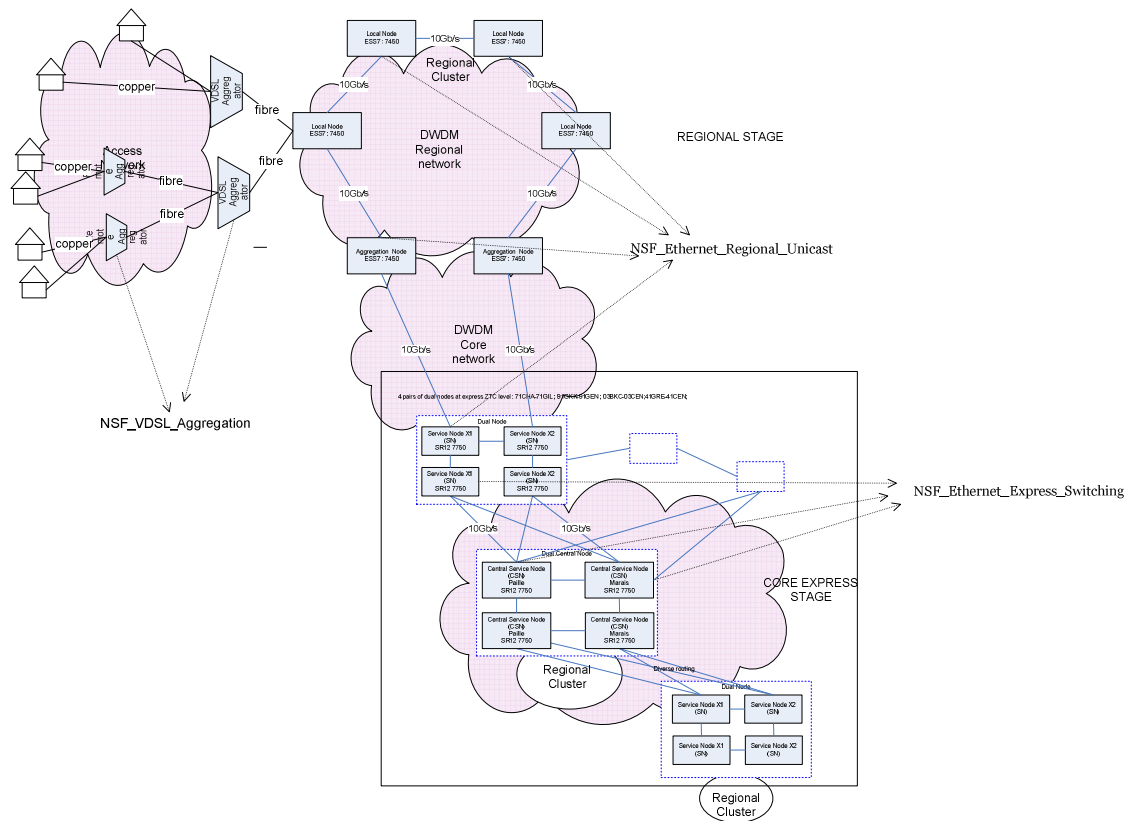

Figure 23 - Ethernet layer 2.1

Finally the dedicated Ethernet transparent connection services NLS2_1_LocalTailCapacity_Ethernet>=10M, NLS2_1_XXX_BackboneCapacity_Ethernet>=10M

are realized either on SDH equipment (up to 100 Mbps), reusing the SDH clusters deployed and already discussed in 7.5.3 (NE_PDH SDH equipment over NE_fibre infrastructure) or for very high capacity connections (above 100 Mbps) they are directly realized on a wavelength (deployed as NLS1_0_Fibre_connect_to_the_office over NE_fibre infrastructure for the local tail and as NE_(D)WDM equipment over NE_fibre infrastructure for the other cases).

The table hereunder summarizes the drivers used to distribute the cost contributors to the NLS2.1 services.

NLS2_1 service category	Building block of layer 2_1 service	Driver name
ATM & Ethernet transport	NE_(D)WDM equipment	yearly direct CAPEX cost
	NE_ATM equipment	yearly direct CAPEX cost
	NE_ethernet equipment	yearly direct CAPEX cost
	NE_Backbone fibre infrastructure	yearly direct CAPEX cost
	NE_PDH SDH equipment	yearly direct CAPEX cost
	NLS2_0_InterCityBackboneCapacity<2M	Bandwidth consumed (Mbit/s)
	NLS2_0_InterCityBackboneCapacity>2M	Bandwidth consumed (Mbit/s)
	NLS2_0_IntraAreaBackboneCapacity>2M	Bandwidth consumed (Mbit/s)
	NLS2_0_IntrazonalBackboneCapacity<2M	Bandwidth consumed (Mbit/s)
	NLS2_0_IntrazonalBackboneCapacity=2M	Bandwidth consumed (Mbit/s)
	NLS2_0_IntrazonalBackboneCapacity>2M	Bandwidth consumed (Mbit/s)
	NLS2_0_LocalBackboneCapacity<2M	Bandwidth consumed (Mbit/s)
	NLS2_0_LocalBackboneCapacity>2M	Bandwidth consumed (Mbit/s)
Broadband aggregation	NE_ADSL equipment	direct
	NE_Access fibre infrastructure	yearly direct CAPEX cost
	NE_NGA Active equipment	direct
	NE_NGA Housing	direct
	NLS1_0_Copper_Localloop_testing	nbr of broadband lex based without voice
	NLS1_0_Copper_Subloop	direct
	NLS1_0_Copper_Subloop_testing	direct
	NLS1_0_Raw_Copper	Nbr_of_used_pairs
	NLS2_0_InterCityBackboneCapacity>2M	Bandwidth consumed (Mbit/s)
	NLS2_0_IntraAreaBackboneCapacity>2M	Bandwidth consumed (Mbit/s)
	NLS2_0_IntrazonalBackboneCapacity>2M	Bandwidth consumed (Mbit/s)
NLS2_0_LocalBackboneCapacity>2M	Bandwidth consumed (Mbit/s)	
Ethernet local tail	NE_ethernet equipment	yearly direct CAPEX cost
	NLS1_0_Continue_Raw_Copper	Nbr_of_used_pairs
	NLS1_0_Fibre_connect_to_the_office	yearly direct CAPEX cost
	NLS1_0_Raw_Copper	Nbr_of_used_pairs
	NLS2_0_LocalTail>2M	Nbr_of_Customer_sites
NLS2_1_Access_into_VirtualPath	NE_ATM equipment	yearly direct CAPEX cost
NLS2_1_Backbone_MulticastVPLS_IntraRegion	NE_(D)WDM equipment	yearly direct CAPEX cost
	NE_ethernet equipment	yearly direct CAPEX cost
	NE_fibre infrastructure	yearly direct CAPEX cost
Transparent Ethernet connection services	NE_(D)WDM equipment	yearly direct CAPEX cost
	NE_fibre infrastructure	yearly direct CAPEX cost
	NE_PDH SDH equipment	yearly direct CAPEX cost
	NLS1_0_Fibre_connect_to_the_office	yearly direct CAPEX cost

7.7 Network services of the IP infrastructure layer (NLS3-IP)

7.7.1 Scope

This layer provides the following basic IP services in the model.

IP service type	IP service
Collection of IP traffic for public internet or internal internet	NLS3_ADSL_Public_IP_collection
	NLS3_SDSL_Public_IP_collection
	NLS3_VDSL_Public_IP_collection
	NLS3_VoD_IP_collection
	NLS3_VoIP_IP_collection
	NLS3_Public_IP_Extension_on_symmetric
Public Internet routing	NLS3_Public_IP_switching
Connection of IP sites to IP-VPN	NLS3_Private_IP&Ethernet_Extension_on_symmetric_HighEnd
	NLS3_Private_IP&Ethernet_Extension_on_symmetric_LowEnd
	NLS3_Private_IP&Ethernet_Routing
	NLS3_Private_IP&Ethernet_Extension_on_asymmetric
	NLS3_Private_IP&Ethernet_Extension_on_symmetric_Datacenter
IP security	NLS3_IP_security

The actual NLS3's are described next. A comprehensive listing of which NLS or EUS they contribute to together with a description of the driver utilized in each case is also presented. Finally, a table will exhibit the cost allocation of these layer services, including driver and driver volume.

7.7.1.1 Public services

7.7.1.1.1 IP_collection

Gathers all the data traffic, except that of the private networks, generated by the customers at their locations -homes and offices placed all over the country- at the highest network level where it can be further delivered to the Internet.

This gathering is achieved thanks to the broad and narrow band servers together with the connectivity capabilities of the ATM and MPLS backbone networks.

This generic service is in fact divided in several actual NLS3, depending on the traffic type and/or underlying technology, as follows:

- Data traffic:
 - NLS3_ADSL_Public_IP_Collection
 - NLS3_SDSL_Public_IP_Collection
 - NLS3_VDSL_Public_IP_Collection

- NLS3_Public_IP_Extension_on_symmetric: where the customer-IP router connectivity is provided by means of Leased Lines, as opposed to the other services which are based on broadband access technologies.
- Video on Demand traffic:
 - NLS3_VoD_IP_Collection
- Voice over IP traffic:
 - NLS3_VoIP_IP_Collection

Further, these NLS3's contribute to the following higher network layer services and end user services (EUS) and they do it as specified hereunder:

- Each of the “data traffic” IP collection contributes to the EUS_FastInternet subscription and the corresponding EUS_xDSL_Carrier_wholesale subscription, according to its technology. The cost allocation of each NLS3 into the peer EUS is done based on the driver “Nbr_of_retail_wholesale_xDSL_lines” -where the “x” must be substituted by the appropriate letter according to the treated technology- so that the cost proportion of the retail lines will be allocated to EUS_FastInternet subscription and that of the wholesale lines to EUS_xDSL_Carrier_wholesale subscription.
- NLS3_VoD_IP_Collection and NLS3_VoIP_IP_Collection and directly, fully and respectively allocated to NLS4.o_VoD and NLS4.o_PSTN_Access.

7.7.1.1.2 Public IP switching

This service brings the intelligence to route the gathered traffic by the “IP_collection” generic NLS3 into the appropriate external network within the “public Internet”.

This service, NLS3_Public_IP_switching, is fully and exclusively realized by the Belgacom Internet Routers and is totally dedicated to the end user service EUS_FastInternet subscription.

7.7.1.2 Private services

7.7.1.2.1 Private IP&Ethernet Extension

This NLS transparently extends the customer's private local area networks, situated at any location within Belgium, to the edge of the Belgacom's network, thanks to the routers installed at the customer premises (CPE) and the connectivity capabilities of the ATM and MPLS aggregation and core- clouds.

This generic service consists in fact of several actual services, specific to the access technology type, as follows:

- NLS3_Private_IP&Ethernet_Extension_on_symmetric_Datacenter
- NLS3_Private_IP&Ethernet_Extension_on_asymmetric
- NLS3_Private_IP&Ethernet_Extension_on_symmetric_lowEnd
- NLS3_Private_IP&Ethernet_Extension_on_symmetric_highEnd

Regarding the higher level NLS/EUS to which the above NLS3's deliver their services and their costs allocations:

- The “Extension_on_symmetric_Datacenter” service only supports the EUS_Private_IP&Ethernet_on_symmetric_Datacenter and therefore the NLS costs are fully allocated to EUS_DataManagedServices (Driver=>direct).

- Each of the remaining three NLS3's offers its services to its analogous "EUS_Private_IP&Ethernet... subscription - National" and to EUS_Private_IP&Ethernet_on_backup. The NLS costs are allocated according to the number of main and backup accesses, respectively. This driver is generically named "Nbr_sites_xxxx", where xxxx needs to be replaced by the appropriate collection of access technologies depending on the addressed NLS3, i.e. Nbr_sites_ADSL_VDSL.

7.7.1.2.2 NLS3_Private_IP&Ethernet_Routing

This NLS delivers the capability of routing the private networks traffic to the requested end point, within the Belgacom private IPVPN network.

This service, NLS3_Private_IP&Ethernet_Routing, is completed by the Belgacom IPVPN Routers and the core MPLS cloud and, in turn, supports all the "EUS_Private_IP&Ethernet... subscription - National".

The costs of this NLS3 are distributed over all the target EUS according to the amount of traffic routed by the Belgacom Private IP network at its busy hour that is generated by the corresponding collection of accesses types (i.e. international, asymmetric, etc...) to the EUS. This driver is named "TotalPeakBandwidth_used(Gbps)".

Figure 24 exhibits the layer's basic topology and all the contributors to the Layer 3 services.

NLS3 - IP

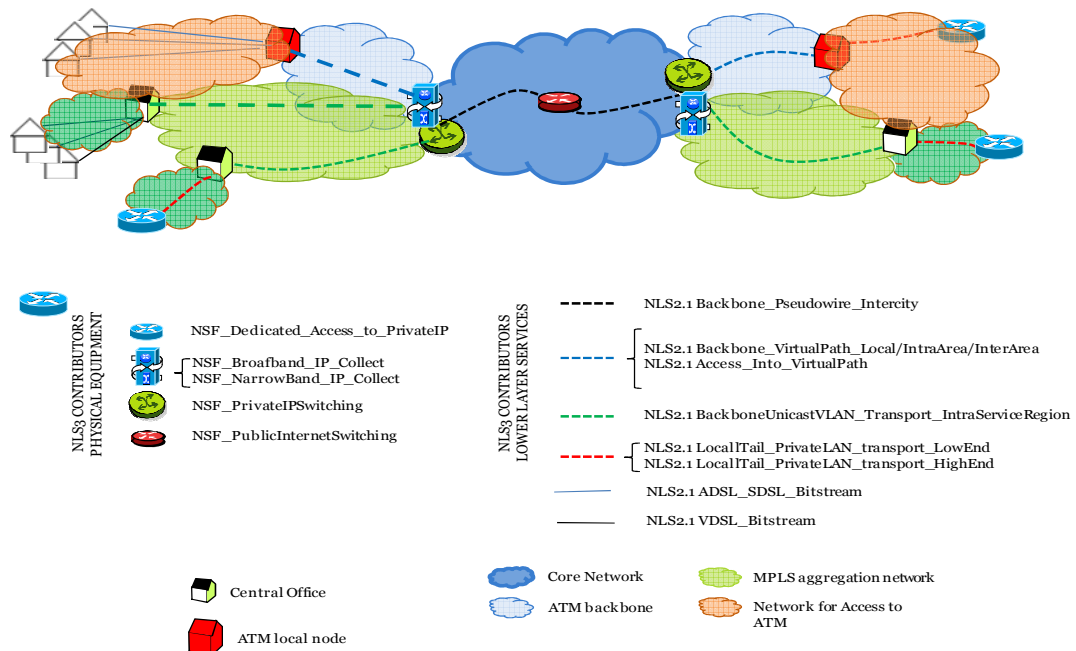



Figure 24: Layer 3 topology and contributors

7.7.2 Contributors to the Network Layer 3 services

7.7.2.1 Components (Physical equipment)



At this layer, a clear distinction appears between the equipment and offered services for private/corporate networks, namely IP-VPN services, and that for the public network.

- Related to private networks:
 -  Customer Premises Equipment (CPE): This is to say the switches/routers located at the customer's premises all over the country. Their costs are grouped into the NSF_Dedicated_Access_to_PrivateIP.

Since the costs borne by this NSF are allocated to several NLS3's, as follows:

- NLS3_Private_IP&Ethernet_Extension_on_asymmetric
- NLS3_Private_IP&Ethernet_Extension_on_symmetric_LowEnd
- NLS3_Private_IP&Ethernet_Extension_on_symmetric_HighEnd
- NLS3_Private_IP&Ethernet_Extension_on_symmetric_DataCenter

the driver for such allocation is the number of accesses for the corresponding access type (asymmetric, symmetric...). This driver is named "Nbr_of_Sites".

-  Provider Edge (PE) routers for IPVPN or VPLS: These MPLS routers, located at major Belgacom regional nodes distributed throughout the country, carry out the actual corporate networks data routing. The Network Stage Function NSF_PrivateIPSwitching bears their total costs.
- Related to the "public" network:
 -  Network Access Servers: ensure the authentication and authorization of the users, control the users' down and upstream, concentrate the traffic received from the access side and routes it towards the right ISP. Belgacom utilizes two types:
 - BAS and MSR (Broadband Access Server & Multi Service Router): their costs are allocated into different NSF depending on the traffic type:
 - NSF_Broadband_Public_IP_Collect
 - NSF_Broadband_VoD_IP_Collect
 - NSF_Broadband_VoIP_IP_Collect

The driver used for such distribution is the "Total_tributary_capacity(Gbps)", which is installed I/O capacity on the equipment interface for each type of traffic.



Further, these NSF are allocated into NLS3's as follows:

- NSF_Broadband_Public_IP_Collect is distributed through all the NLS3_xDSL_Public_IP_Collection services, where the x stands for any of the three possible DSL flavors –ADSL, SDSL, VDSL-. The driver used in this case is "PeakHour_PublicInternetTraffic(Gbps)", meaning that the costs will be allocated according to the amount of internet traffic carried by the Belgacom public network at the internet traffic busy hour generated by the different DSL types.

- NSF_Broadband_VoD_IP_Collect is directly allocated to NLS3_VoD_IP_Collection, although the driver “PeakHour_VoDTraffic(Gbps)” –carried VoD traffic at the VoD busy hour- has been assigned to it.
 - NSF_Broadband_VoIP_IP_Collect: direct allocation to NLS3_VoIP_IP_Collection.
-  Collection of IP equipments -FIFA routers, acting as gateway to the “Public Internet” and located at a very reduced number of key Belgacom technical buildings. Their costs are summed up into the Network Stage Function NSF_PublicInternetSwitching which in turn are directly allocated to NLS3_Public_IP_switching via the driver “TotalPeakHour_PublicInternetTraffic(Gbps)”, that is to say retail Internet traffic at Internet Busy Hour.

7.7.2.2 Lower layer services

At this layer, the clouds provide the NLS3's with connectivity, allowing the transmission of data amongst the Layer 3 equipments. The clouds deliver services to both private and public service meanwhile the tails are specific to the private networks. These clouds are:

- ATM based cloud :
 - NLS2.1_ADSL_SDSL_Bitstream
 - NLS2.1_VDSL_Bitstream
 - NLS2.1_Access_into_VirtualPath
 - NLS2_1_Backbone_VirtualPath_InterArea
 - NLS2_1_Backbone_VirtualPath_IntraArea
 - NLS2_1_Backbone_VirtualPath_Local
 - NLS2_o_InterCityBackboneCapacity<2M
 - NLS2_o_InterCityBackboneCapacity=2M
 - NLS2_o_InterCityBackboneCapacity>2M
 - NLS2_o_IntraAreaBackboneCapacity<2M
 - NLS2_o_IntraAreaBackboneCapacity=2M
 - NLS2_o_IntraAreaBackboneCapacity>2M
 - NLS2_o_IntrazonalBackboneCapacity<2M
 - NLS2_o_IntrazonalBackboneCapacity=2M
 - NLS2_o_IntrazonalBackboneCapacity>2M
 - NLS2_o_LocalBackboneCapacity<2M
 - NLS2_o_LocalBackboneCapacity=2M
 - NLS2_o_LocalBackboneCapacity>2M
- Ethernet based cloud :
 - NLS2.1_Backbone_UnicastVLAN_Transport_IntraServiceRegion
 - NLS2.1_Backbone_Pseudowire_InterCity
 - NLS2_1_BackboneCapacity_Ethernet>=10M
 - NLS2_1_BackboneCapacity_Ethernet>=10M
 - NLS2_1_InterCityBackboneCapacity_Ethernet>=10M
- Access network :

- NLS2.1_LocalTail_PrivateVLAN_transport_lowEnd
- NLS2.1_LocalTail_PrivateVLAN_transport_HighEnd
- NLS2_1_LocalTailCapacity_Ethernet>=10M
- NLS2_o_LocalTail<2M
- NLS2_o_LocalTail=2M
- NLS2_o_LocalTail>2M

These clouds are described in their corresponding layer.

7.8 Network Services of the application layer

7.8.1 Definition

This layer deals with the telecommunication application services to end users. The application layer services are :

NLS4_o_BroadcastTV, NLS4_o_VoD and 41 voice telephony related services classified as follows:

CLASS	DEF_NLS_DESCR
Access to VoiceCallHandling	NLS4_0_Voice_traffic_AreaLevel_Aggregate_Deaggregate NLS4_0_Voice_traffic_AreaLevel_PointOfInterconnect NLS4_0_Voice_traffic_Local_Aggregate_Deaggregate NLS4_0_Voice_traffic_Local_PointOfInterconnect
NP	NLS4_0_FixedPortableNumberLocation NLS4_0_Public_NumberPortability
Telephony Access	NLS4_0_ISDN_access NLS4_0_ISDN-PRA_access NLS4_0_PSTN_access
VAS application	NLS4_0_Advanced_Number_Translation_CallHandling NLS4_0_CallerIdentity_CallHandling NLS4_0_CallingCard_CallHandling NLS4_0_InteractiveVoiceResponse_CallHandling NLS4_0_MessageWaitingIndicator_Inserting NLS4_0_OtherAdvanced_CallHandling NLS4_0_PrepaidCallingCard_CallHandling NLS4_0_Service_Announcements_Playing NLS4_0_Tele voting_CallHandling NLS4_0_VirtualPrivateNetwork_CallHandling NLS4_0_VoiceFeatures_SelfManaging NLS4_0_Voicemail&Messaging NLS4_0_WakeUp_CallHandling
Voice transport	NLS4_0_RemotelyAggregatedVoice_transport NLS4_0_SwitchedVoice_transport_CAE_CAE NLS4_0_FixedSwitchedVoice_transport_National_offnet NLS4_0_SwitchedVoice_transport_LEX_CAE NLS4_0_BGC MobileSwitchedVoice_transport_National_offnet NLS4_0_SwitchedVoice_transport_CAE_MSC NLS4_0_SwitchedVoice_transport_LEX_MSC
VoiceCallHandling	NLS4_0_Voice_traffic_AreaLevel_Collect NLS4_0_Voice_traffic_AreaLevel_Complete

	NLS4_0_Voice_traffic_AreaLevel_Terminate
	NLS4_0_Voice_traffic_AreaLevel_Transit
	NLS4_0_Voice_traffic_Local_Collect
	NLS4_0_Voice_traffic_Local_Complete
	NLS4_0_Voice_traffic_Local_Terminate
Mobile Voice&Data Handling	NLS4_0_BGC Mobile_Access_Collect
	NLS4_0_BGC Mobile_Access_Distribute
	NLS4_0_BGC Mobile_BackBone
Special	NLS4_0_Automated_call_distribution
	NLS4_0_PublicPayphones
Other special	NLS4_0_InternetDialUp_CallHandling

For the access, the voice application services are end-to-end voice connections between the customer site and the central office (technical building closest to the user) . For the backbone voice applications are either pure call handling related and do not span over distant nodes, or they are voice transport applications between distant nodes . Next picture puts into perspective the services of the Voice application layer.

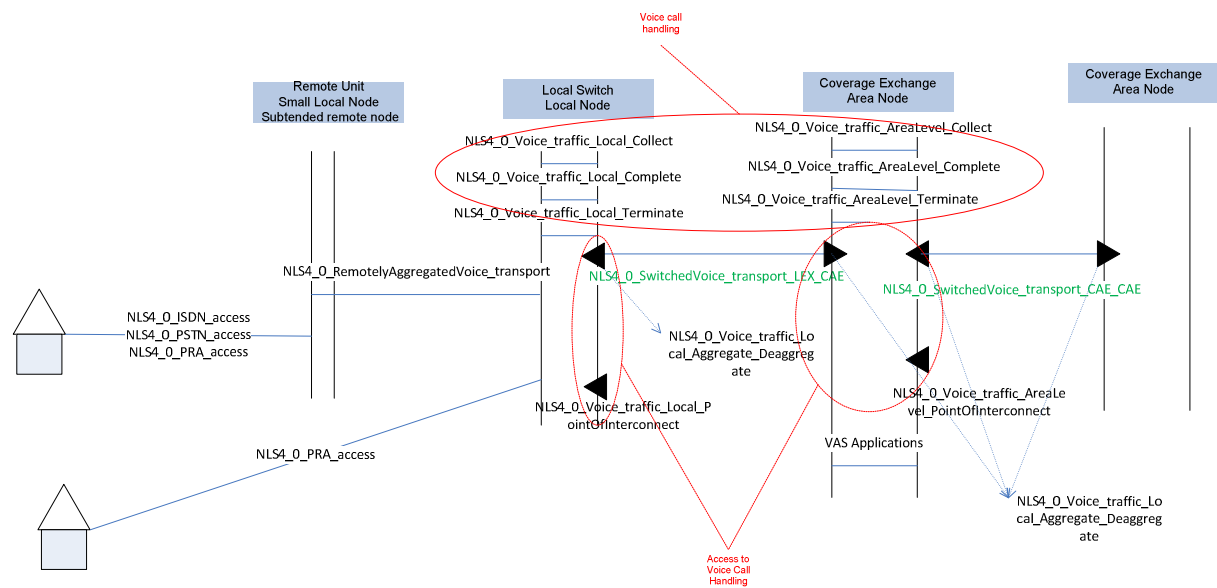

7.8.2 Usage of the application layer

The TV related applications are completely used for iDTV end-user services, no specific consumption driver needs to be defined.

The voice application services are distributed to a variety of traffic types , each with a specific driver. The following table summarizes the used drivers per voice application service.

Class of application service	Voice application service	Driver to distribute the NLS4.0 application service to EUS or NLS4.1
------------------------------	---------------------------	--

Access to		
VoiceCallHandling	NLS4_0_Voice_traffic_AreaLevel_Aggregate_Deaggregate	routed minutes
	NLS4_0_Voice_traffic_AreaLevel_PointOfInterconnect	TimeSlotEquivalent_capacity_used
	NLS4_0_Voice_traffic_Local_Aggregate_Deaggregate	routed minutes
	NLS4_0_Voice_traffic_Local_PointOfInterconnect	TimeSlotEquivalent_capacity_used
NP	NLS4_0_FixedPortableNumberLocation	Nbr_calls
	NLS4_0_Public_NumberPortability	Nbr_of_ported_numbers
Telephony Access	NLS4_0_ISDN_access	Nbr_lines_inUse
	NLS4_0_ISDN-PRA_access	Nbr_lines_inUse
	NLS4_0_PSTN_access	Nbr_lines_inUse
VAS application	NLS4_0_Advanced_Number_Translation_CallHandling	NumberTranslationProcessedTime(min)
	NLS4_0_CallerIdentity_CallHandling	direct
	NLS4_0_CallingCard_CallHandling	direct
	NLS4_0_InteractiveVoiceResponse_CallHandling	direct
	NLS4_0_MessageWaitingIndicator_Inserting	direct
	NLS4_0_OtherAdvanced_CallHandling	Direct
	NLS4_0_PrepaidCallingCard_CallHandling	Direct
	NLS4_0_Service_Announcements_Playing	Nbr_calls
	NLS4_0_Televoting_CallHandling	Nbr_calls_explosive_traffic
	NLS4_0_VirtualPrivateNetwork_CallHandling	direct
	NLS4_0_VoiceFeatures_SelfManaging	direct
	NLS4_0_Voicemail&Messaging	direct
	NLS4_0_WakeUp_CallHandling	direct
Voice transport	NLS4_0_RemotelyAggregatedVoice_transport	routed minutes
	NLS4_0_SwitchedVoice_transport_CAE_CAE	routed minutes
	NLS4_0_FixedSwitchedVoice_transport_National_offnet	TimeSlotEquivalent_capacity_used
	NLS4_0_SwitchedVoice_transport_LEX_CAE	routed minutes
	NLS4_0_BGC	
	MobileSwitchedVoice_transport_National_offnet	routed minutes
	NLS4_0_SwitchedVoice_transport_CAE_MSC	routed minutes
	NLS4_0_SwitchedVoice_transport_LEX_MSC	routed minutes
VoiceCallHandling	NLS4_0_Voice_traffic_AreaLevel_Collect	routed minutes
	NLS4_0_Voice_traffic_AreaLevel_Complete	routed minutes
	NLS4_0_Voice_traffic_AreaLevel_Terminate	routed minutes
	NLS4_0_Voice_traffic_AreaLevel_Transit	routed minutes
	NLS4_0_Voice_traffic_Local_Collect	routed minutes
	NLS4_0_Voice_traffic_Local_Complete	routed minutes
	NLS4_0_Voice_traffic_Local_Terminate	routed minutes
Mobile Voice&Data Handling	NLS4_0_BGC Mobile_Access_Collect	routed minutes
	NLS4_0_BGC Mobile_Access_Distribute	routed minutes
	NLS4_0_BGC Mobile_BackBone	routed minutes

The driver “routed minutes” consists in determining the average nbr of times (=routing factor) a traffic type is using the voice application service across all possible call scenarios compatible with the traffic type. The routed minutes result from multiplication of the routing factor with the amount of calls (expressed in minutes) of that traffic type.

The traffic types (“consumers”) of these voice applications are:

Class of voice application	Traffic type
Access to VoiceCallHandling	EUS_BGC Fixed National Transit (M)OLO traffic EAA interconnection
	EUS_BGC Fixed to BGC Mobile
	EUS_BGC Mobile to BGC Fixed
	EUS_BGC Mobile_Roaming Out Origination
	EUS_Carrier PreSelection IAA interconnection
	EUS_EAA interconnection - BGC Fixed to FOLO

Mobile Voice&Data Handling

EUS_EAA interconnection - BGC Fixed to MOLO
 EUS_EAA interconnection - (M)FOLO to BGC Fixed
 EUS_IAA interconnection - MOLO to BGC Fixed
 EUS_IAA interconnection - BGC Fixed to MOLO
 EUS_Mobile_Roaming IN Origination
 EUS_MVAS - BGC Fixed
 NLS4_1_BVAS - BGC Fixed
 NLS4_1_EAA BGC Fixed_On net Voice
 NLS4_1_IAA BGC Fixed_On net Voice
 NLS4_1_IAA interconnection - BGC Fixed to FOLO
 NLS4_1_IAA interconnection - FOLO to BGC Fixed
 NLS4_1_Incoming International Traffic - BGC Fixed
 NLS4_1_Outgoing International Traffic - BGC Fixed
 NLS4_1_Transit International (M)OLO Traffic EAA
 EUS_BGC Fixed to BGC Mobile
 EUS_BGC Mobile National outg. FOLO
 EUS_BGC Mobile to BGC Fixed
 EUS_BGC Mobile_Roaming Out Origination
 EUS_EAA interconnection - BGC Fixed to FOLO
 EUS_EAA interconnection - BGC Fixed to MOLO
 EUS_IAA interconnection - BGC Fixed to MOLO
 EUS_Mobile_Roaming IN Origination
 EUS_Voice_traffic_IAA_PointOfInterconnect subscription
 NLS4_1_IAA interconnection - BGC Fixed to FOLO
 NLS4_1_Outgoing International Traffic - BGC Fixed
 EUS_BGC Fixed to BGC Mobile
 EUS_BGC Mobile to BGC Fixed
 EUS_BGC Mobile_Roaming Out Origination
 EUS_Carrier PreSelection IAA interconnection
 EUS_EAA interconnection - BGC Fixed to FOLO
 EUS_EAA interconnection - BGC Fixed to MOLO
 EUS_EAA interconnection - (M)FOLO to BGC Fixed
 EUS_IAA interconnection - MOLO to BGC Fixed
 EUS_IAA interconnection - BGC Fixed to MOLO
 EUS_Mobile_Roaming IN Origination
 EUS_MVAS - BGC Fixed
 NLS4_1_BVAS - BGC Fixed
 NLS4_1_EAA BGC Fixed_On net Voice
 NLS4_1_IAA BGC Fixed_On net Voice
 NLS4_1_IAA interconnection - BGC Fixed to FOLO
 NLS4_1_IAA interconnection - FOLO to BGC Fixed
 NLS4_1_Incoming International Traffic - BGC Fixed
 NLS4_1_Outgoing International Traffic - BGC Fixed
 EUS_BGC Mobile to BGC Fixed
 EUS_BGC Mobile_Roaming Out Origination
 EUS_Mobile_Roaming IN Origination
 EUS_Voice_traffic_Local_PointOfInterconnect subscription
 NLS4_1_Outgoing International Traffic - BGC Fixed
 EUS_BGC Mobile National outg. FOLO
 EUS_BGC Mobile Outgoing to International Traffic
 EUS_BGC Mobile to BGC Fixed
 EUS_BGC Mobile to BGC Mobile
 EUS_Interconnection BGC Mobile to MOLO
 EUS_Mobile_Data national
 EUS_Mobile_On net SMS
 EUS_Mobile_Outgoing SMS_international
 EUS_Mobile_Outgoing SMS_national

	EUS_Mobile_Roaming IN Origination
	EUS_Mobile_Roaming IN_Data
	EUS_Mobile_Roaming IN_Originating_SMS
	EUS_BGC Fixed National Transit (M)OLO traffic IAA interconnection
	EUS_BGC Fixed to BGC Mobile
	EUS_BGC Mobile international traffic incoming
	EUS_BGC Mobile to BGC Mobile
	EUS_BGC Mobile_Incoming SMS international
	EUS_BGC Mobile_Incoming SMS national
	EUS_Interconnection FOLO to BGC Mobile
	EUS_Interconnection MOLO to BGC Mobile
	EUS_Mobile_On net SMS
	EUS_Mobile_Roaming IN Origination
	EUS_Mobile_Roaming IN Termination
	EUS_Mobile_Roaming IN_Originating_SMS
	EUS_Mobile_Roaming IN_Terminating_SMS
	EUS_BGC Fixed National Transit (M)OLO traffic IAA interconnection
	EUS_BGC Fixed to BGC Mobile
	EUS_BGC Mobile international traffic incoming
	EUS_BGC Mobile National outg. FOLO
	EUS_BGC Mobile Outgoing to International Traffic
	EUS_BGC Mobile to BGC Fixed
	EUS_BGC Mobile to BGC Mobile
	EUS_BGC Mobile_Incoming SMS international
	EUS_BGC Mobile_Incoming SMS national
	EUS_BGC Mobile_Roaming Out Termination
	EUS_Interconnection BGC Mobile to MOLO
	EUS_Interconnection FOLO to BGC Mobile
	EUS_Interconnection MOLO to BGC Mobile
	EUS_Mobile_Data national
	EUS_Mobile_On net SMS
	EUS_Mobile_Outgoing SMS_international
	EUS_Mobile_Outgoing SMS_national
	EUS_Mobile_Roaming IN Origination
	EUS_Mobile_Roaming IN Termination
	EUS_Mobile_Roaming IN_Data
	EUS_Mobile_Roaming IN_Originating_SMS
	EUS_Mobile_Roaming IN_Terminating_SMS
NP	EUS_BGC Fixed National Transit (M)OLO traffic EAA interconnection
	EUS_BGC Fixed National Transit (M)OLO traffic IAA interconnection
	EUS_EAA interconnection - BGC Fixed to FOLO
	EUS_IAA interconnection - BGC Fixed to FOLO
	EUS_Incoming International Transit (M)OLO Traffic
	EUS_Other_Traffic - BGC Fixed
	EUS_Number Portability access per line subscription
Special	EUS_AUTOMATEDCALLDISTRIBUTION
	EUS_Payph operations - BGC Fixed
Telephony Access	EUS_ISDN-BA Access - subscription
	EUS_Private_IP&Ethernet_on_backup
	EUS_ISDN-PRA Access - subscription
	EUS_PSTN Access - subscription
VAS application	EUS_BGC Fixed National Transit (M)OLO traffic EAA interconnection
	EUS_BGC Fixed National Transit (M)OLO traffic IAA interconnection
	EUS_BGC Fixed Outgoing International Freephone traffic
	EUS_Consultel 090x Traffic - BGC Fixed&Mobile to BGC
	EUS_Consultel 090x Traffic - BGC Fixed&Mobile to FOLO

EUS_Consultel 090x Traffic - FOLO to BGC Fixed
 EUS_Freephone Traffic - (M)FOLO to BGC
 EUS_Freephone Traffic - BGC Fixed and Mobile to FOLO
 EUS_Freephone Traffic - BGC Fixed&Mobile to BGC
 EUS_Incoming International Freephone Traffic (OLO+BGC mobile) to BGC
 EUS_Incoming International Transit (M)OLO Traffic
 EUS_Outgoing International Transit (M)OLO Traffic
 EUS_Split Charging Traffic - BGC Fixed&Mobile to BGC
 EUS_Split Charging Traffic - BGC Fixed&Mobile to FOLO
 EUS_Split Charging Traffic - FOLO to BGC Fixed
 EUS_Universal Access Number Traffic - BGC fixed&Mobile to BGC
 EUS_Universal Access Number Traffic - BGC Fixed&Mobile to FOLO
 EUS_Universal Access Number Traffic - FOLO to BGC Fixed
 EUS_MVAS - BGC Fixed
 EUS_Calling Card Postpaid Traffic - BGC Fixed
 EUS_MVAS - BGC Fixed
 EUS_MVAS - BGC Fixed
 EUS_notAllocated
 EUS_Calling Card Prepaid Traffic - BGC Fixed
 EUS_notAllocated
 EUS_BGC Fixed DCIA traffic
 EUS_BGC Fixed international traffic incoming
 EUS_BGC Fixed interzonal traffic
 EUS_BGC Fixed local traffic
 EUS_BGC Fixed National Transit (M)OLO traffic IAA interconnection
 EUS_BGC Fixed zonal non local traffic
 EUS_BVAS Call & Conference - BGC fixed
 EUS_Calling Card Postpaid Traffic - BGC Fixed
 EUS_Carrier PreSelection IAA interconnection
 EUS_Carrier PreSelection local interconnection
 EUS_Freephone Traffic - BGC Fixed&Mobile to BGC
 EUS_IAA interconnection - MOLO to BGC Fixed
 EUS_IAA interconnection - BGC Fixed to MOLO
 EUS_Local interconnection - FOLO to BGC Fixed
 EUS_OPS International Information Traffic - BGC
 EUS_OPS National Information Traffic - BGC
 EUS_Payph operations - BGC Fixed
 NLS4_1_IAA interconnection - BGC Fixed to FOLO
 NLS4_1_IAA interconnection - FOLO to BGC Fixed
 NLS4_1_Outgoing International Traffic - BGC Fixed
 EUS_Consultel 090x Traffic - BGC Fixed&Mobile to BGC
 EUS_Consultel 090x Traffic - FOLO to BGC Fixed
 EUS_Other_Traffic - BGC Fixed
 EUS_MVAS - BGC Fixed
 EUS_MVAS - BGC Fixed
 EUS_MVAS - BGC Fixed
 EUS_BGC Mobile international traffic incoming
 EUS_BGC Mobile Outgoing to International Traffic
 EUS_BGC Mobile_Incoming SMS international
 EUS_BGC Mobile_Incoming SMS national
 EUS_BGC Mobile_Roaming Out Termination
 EUS_Interconnection BGC Mobile to MOLO
 EUS_Interconnection FOLO to BGC Mobile
 EUS_Interconnection MOLO to BGC Mobile
 EUS_Mobile_Outgoing SMS_international
 EUS_Mobile_Outgoing SMS_national
 EUS_Mobile_Roaming IN Origination

Voice transport

EUS_Mobile_Roaming IN Termination
EUS_Mobile_Roaming IN_Originating_SMS
EUS_EAA interconnection - BGC Fixed to FOLO
EUS_EAA interconnection - BGC Fixed to MOLO
EUS_IAA interconnection - BGC Fixed to MOLO
NLS4_1_IAA interconnection - BGC Fixed to FOLO
NLS4_1_Outgoing International Traffic - BGC Fixed
EUS_BGC Fixed to BGC Mobile
EUS_BGC Mobile to BGC Fixed
EUS_BGC Mobile_Roaming Out Origination
EUS_Carrier PreSelection local interconnection
EUS_EAA interconnection - BGC Fixed to FOLO
EUS_EAA interconnection - BGC Fixed to MOLO
EUS_EAA interconnection - (M)FOLO to BGC Fixed
EUS_IAA interconnection - MOLO to BGC Fixed
EUS_IAA interconnection - BGC Fixed to MOLO
EUS_Local interconnection - FOLO to BGC Fixed
EUS_Mobile_Roaming IN Origination
EUS_MVAS - BGC Fixed
NLS4_1 BVAS - BGC Fixed
NLS4_1_EAA BGC Fixed_On net Voice
NLS4_1_IAA BGC Fixed_On net Voice
NLS4_1_IAA interconnection - BGC Fixed to FOLO
NLS4_1_IAA interconnection - FOLO to BGC Fixed
NLS4_1_Incoming International Traffic - BGC Fixed
NLS4_1_Local BGC Fixed_On net Voice
NLS4_1_Outgoing International Traffic - BGC Fixed
EUS_BGC Fixed National Transit (M)OLO traffic EAA interconnection
EUS_EAA interconnection - BGC Fixed to FOLO
EUS_EAA interconnection - BGC Fixed to MOLO
EUS_EAA interconnection - (M)FOLO to BGC Fixed
NLS4_1_EAA BGC Fixed_On net Voice
NLS4_1_Transit International (M)OLO Traffic EAA
EUS_BGC Fixed National Transit (M)OLO traffic IAA interconnection
EUS_BGC Fixed to BGC Mobile
EUS_BGC Mobile National outg. FOLO
EUS_BGC Mobile to BGC Fixed
EUS_Mobile_Roaming IN Origination
EUS_BGC Fixed to BGC Mobile
EUS_BGC Mobile to BGC Fixed
EUS_BGC Mobile_Roaming Out Origination
EUS_EAA interconnection - BGC Fixed to FOLO
EUS_EAA interconnection - BGC Fixed to MOLO
EUS_EAA interconnection - (M)FOLO to BGC Fixed
EUS_IAA interconnection - MOLO to BGC Fixed
EUS_IAA interconnection - BGC Fixed to MOLO
EUS_Mobile_Roaming IN Origination
EUS_MVAS - BGC Fixed
NLS4_1 BVAS - BGC Fixed
NLS4_1_EAA BGC Fixed_On net Voice
NLS4_1_IAA BGC Fixed_On net Voice
NLS4_1_IAA interconnection - BGC Fixed to FOLO
NLS4_1_IAA interconnection - FOLO to BGC Fixed
NLS4_1_Incoming International Traffic - BGC Fixed
NLS4_1_Outgoing International Traffic - BGC Fixed
EUS_BGC Mobile to BGC Fixed
EUS_Mobile_Roaming IN Origination

VoiceCallHandling

EUS_BGC Fixed to BGC Mobile
 EUS_Carrier PreSelection IAA interconnection
 EUS_EAA interconnection - BGC Fixed to FOLO
 EUS_EAA interconnection - BGC Fixed to MOLO
 EUS_IAA interconnection - BGC Fixed to MOLO
 EUS_MVAS - BGC Fixed
 NLS4_1_EAA BGC Fixed_On net Voice
 NLS4_1_IAA interconnection - BGC Fixed to FOLO
 NLS4_1_Outgoing International Traffic - BGC Fixed
 NLS4_1_BVAS - BGC Fixed
 NLS4_1_IAA BGC Fixed_On net Voice
 EUS_BGC Mobile to BGC Fixed
 EUS_BGC Mobile_Roaming Out Origination
 EUS_EAA interconnection - (M)FOLO to BGC Fixed
 EUS_IAA interconnection - MOLO to BGC Fixed
 EUS_Mobile_Roaming IN Origination
 NLS4_1_EAA BGC Fixed_On net Voice
 NLS4_1_IAA interconnection - FOLO to BGC Fixed
 NLS4_1_Incoming International Traffic - BGC Fixed
 EUS_BGC Fixed National Transit (M)OLO traffic EAA interconnection
 EUS_BGC Fixed National Transit (M)OLO traffic IAA interconnection
 EUS_BGC Mobile National outg. FOLO
 EUS_EAA interconnection - BGC Fixed to FOLO
 EUS_EAA interconnection - BGC Fixed to MOLO
 EUS_EAA interconnection - (M)FOLO to BGC Fixed
 EUS_Mobile_Roaming IN Origination
 NLS4_1_Transit International (M)OLO Traffic EAA
 NLS4_1_Transit International (M)OLO Traffic IAA
 EUS_BGC Fixed to BGC Mobile
 EUS_Carrier PreSelection IAA interconnection
 EUS_Carrier PreSelection local interconnection
 EUS_EAA interconnection - BGC Fixed to FOLO
 EUS_EAA interconnection - BGC Fixed to MOLO
 EUS_IAA interconnection - BGC Fixed to MOLO
 EUS_MVAS - BGC Fixed
 NLS4_1_BVAS - BGC Fixed
 NLS4_1_EAA BGC Fixed_On net Voice
 NLS4_1_IAA BGC Fixed_On net Voice
 NLS4_1_IAA interconnection - BGC Fixed to FOLO
 NLS4_1_Outgoing International Traffic - BGC Fixed
 NLS4_1_Local BGC Fixed_On net Voice
 EUS_BGC Mobile to BGC Fixed
 EUS_BGC Mobile_Roaming Out Origination
 EUS_EAA interconnection - (M)FOLO to BGC Fixed
 EUS_IAA interconnection - MOLO to BGC Fixed
 EUS_Local interconnection - FOLO to BGC Fixed
 EUS_Mobile_Roaming IN Origination
 NLS4_1_BVAS - BGC Fixed
 NLS4_1_EAA BGC Fixed_On net Voice
 NLS4_1_IAA BGC Fixed_On net Voice
 NLS4_1_IAA interconnection - FOLO to BGC Fixed
 NLS4_1_Incoming International Traffic - BGC Fixed
 EUS_internet traffic - FOLO to BGC 0909/3 IAA
 EUS_Other_Traffic - BGC Fixed

Other special

Below table gives a view on fixed or mobile related traffic types (“consumers”) of those voice applications:

traffic category	Voice application service	EUS or NLS4_1
mobile traffic related	NLS4_0_BGC Mobile_Access_Collect	EUS_BGC Mobile National outg. FOLO EUS_BGC Mobile Outgoing to International Traffic EUS_BGC Mobile to BGC Fixed EUS_BGC Mobile to BGC Mobile EUS_Interconnection BGC Mobile to MOLO EUS_Mobile_Data national EUS_Mobile_On net SMS EUS_Mobile_Outgoing SMS_international EUS_Mobile_Outgoing SMS_national EUS_Mobile_Roaming IN Origination EUS_Mobile_Roaming IN_Data EUS_Mobile_Roaming IN_Originating_SMS EUS_BGC Fixed National Transit (M)OLO traffic IAA interconnection EUS_BGC Fixed to BGC Mobile EUS_BGC Mobile international traffic incoming EUS_BGC Mobile to BGC Mobile EUS_BGC Mobile_Incoming SMS international EUS_BGC Mobile_Incoming SMS national EUS_Interconnection FOLO to BGC Mobile EUS_Interconnection MOLO to BGC Mobile EUS_Mobile_On net SMS EUS_Mobile_Roaming IN Origination EUS_Mobile_Roaming IN Termination EUS_Mobile_Roaming IN_Originating_SMS EUS_Mobile_Roaming IN_Terminating_SMS EUS_BGC Fixed National Transit (M)OLO traffic IAA interconnection EUS_BGC Fixed to BGC Mobile EUS_BGC Mobile international traffic incoming EUS_BGC Mobile National outg. FOLO EUS_BGC Mobile Outgoing to International Traffic EUS_BGC Mobile to BGC Fixed EUS_BGC Mobile to BGC Mobile EUS_BGC Mobile_Incoming SMS international EUS_BGC Mobile_Incoming SMS national EUS_BGC Mobile_Roaming Out Termination EUS_Interconnection BGC Mobile to MOLO EUS_Interconnection FOLO to BGC Mobile
	NLS4_0_BGC Mobile_Access_Distribute	
	NLS4_0_BGC Mobile_Backbone	

	EUS_Interconnection MOLO to BGC Mobile
	EUS_Mobile_Data national
	EUS_Mobile_On net SMS
	EUS_Mobile_Outgoing SMS_international
	EUS_Mobile_Outgoing SMS_national
	EUS_Mobile_Roaming IN Origination
	EUS_Mobile_Roaming IN Termination
	EUS_Mobile_Roaming IN_Data
	EUS_Mobile_Roaming IN_Originating_SMS
	EUS_Mobile_Roaming IN_Terminating_SMS
NLS4_0_FixedSwitchedVoice_transport_National_offnet	EUS_BGC Mobile National outg. FOLO
	EUS_Mobile_Roaming IN Origination
	NLS4_1_Outgoing International Traffic - BGC Fixed
NLS4_0_MobileSwitchedVoice_transport_National_offnet	EUS_BGC Mobile Outgoing to International Traffic
	EUS_BGC Mobile_Roaming Out Termination
	EUS_Interconnection BGC Mobile to MOLO
	EUS_Mobile_Outgoing SMS_international
	EUS_Mobile_Outgoing SMS_national
	EUS_Mobile_Roaming IN Origination
	EUS_Mobile_Roaming IN_Originating_SMS
NLS4_0_RemotelyAggregatedVoice_transport	EUS_BGC Fixed to BGC Mobile
	EUS_BGC Mobile to BGC Fixed
	EUS_BGC Mobile_Roaming Out Origination
	EUS_Mobile_Roaming IN Origination
	NLS4_1_Outgoing International Traffic - BGC Fixed
NLS4_0_SwitchedVoice_transport_CAE_MSC	EUS_BGC Fixed National Transit (M)OLO traffic IAA interconnection
	EUS_BGC Fixed to BGC Mobile
	EUS_BGC Mobile National outg. FOLO
	EUS_BGC Mobile to BGC Fixed
	EUS_Mobile_Roaming IN Origination
NLS4_0_SwitchedVoice_transport_LEX_CAE	EUS_BGC Fixed to BGC Mobile
	EUS_BGC Mobile to BGC Fixed
	EUS_BGC Mobile_Roaming Out Origination
	EUS_Mobile_Roaming IN Origination
	NLS4_1_Outgoing International Traffic - BGC Fixed
NLS4_0_SwitchedVoice_transport_LEX_MSC	EUS_BGC Mobile to BGC Fixed
	EUS_Mobile_Roaming IN Origination
NLS4_0_Voice_traffic_AreaLevel_Aggregate_Deaggregate	EUS_BGC Fixed to BGC Mobile
	EUS_BGC Mobile to BGC Fixed
	EUS_BGC Mobile_Roaming Out Origination

		EUS_Mobile_Roaming IN Origination NLS4_1_Outgoing International Traffic - BGC Fixed
	NLS4_0_Voice_traffic_AreaLevel_Collect	EUS_BGC Fixed to BGC Mobile NLS4_1_Outgoing International Traffic - BGC Fixed
	NLS4_0_Voice_traffic_AreaLevel_PointOfInterconnect	EUS_BGC Fixed National Transit (M)OLO traffic IAA interconnection EUS_BGC Fixed to BGC Mobile EUS_BGC Mobile National outg. FOLO EUS_BGC Mobile to BGC Fixed EUS_BGC Mobile_Roaming Out Origination EUS_Mobile_Roaming IN Origination NLS4_1_Outgoing International Traffic - BGC Fixed
	NLS4_0_Voice_traffic_AreaLevel_Terminate	EUS_BGC Mobile to BGC Fixed EUS_BGC Mobile_Roaming Out Origination EUS_Mobile_Roaming IN Origination EUS_BGC Fixed National Transit (M)OLO traffic IAA interconnection EUS_BGC Mobile National outg. FOLO EUS_Mobile_Roaming IN Origination
	NLS4_0_Voice_traffic_AreaLevel_Transit	EUS_BGC Mobile to BGC Fixed EUS_BGC Mobile_Roaming Out Origination EUS_Mobile_Roaming IN Origination EUS_BGC Fixed National Transit (M)OLO traffic IAA interconnection EUS_BGC Mobile National outg. FOLO EUS_Mobile_Roaming IN Origination
	NLS4_0_Voice_traffic_Local_Aggregate_Deaggregate	EUS_BGC Fixed to BGC Mobile EUS_BGC Mobile to BGC Fixed EUS_BGC Mobile_Roaming Out Origination EUS_Mobile_Roaming IN Origination NLS4_1_Outgoing International Traffic - BGC Fixed
	NLS4_0_Voice_traffic_Local_Collect	EUS_BGC Fixed to BGC Mobile NLS4_1_Outgoing International Traffic - BGC Fixed
	NLS4_0_Voice_traffic_Local_PointOfInterconnect	EUS_BGC Mobile to BGC Fixed EUS_BGC Mobile_Roaming Out Origination EUS_Mobile_Roaming IN Origination NLS4_1_Outgoing International Traffic - BGC Fixed
	NLS4_0_Voice_traffic_Local_Terminate	EUS_BGC Mobile to BGC Fixed EUS_BGC Mobile_Roaming Out Origination EUS_Mobile_Roaming IN Origination EUS_BGC Fixed National Transit (M)OLO traffic EAA interconnection EUS_BGC Fixed National Transit (M)OLO traffic IAA interconnection EUS_EAA interconnection - BGC Fixed to FOLO EUS_EAA interconnection - BGC Fixed to MOLO EUS_IAA interconnection - BGC Fixed to
pure fixed traffic related	NLS4_0_FixedSwitchedVoice_transport_National_offnet	

	MOLO
	NLS4_1_IAA interconnection - BGC Fixed to FOLO
	NLS4_1_Outgoing International Traffic - BGC Fixed
	NLS4_1_Transit International (M)OLO Traffic EAA
	NLS4_1_Transit International (M)OLO Traffic IAA
NLS4_0_RemotelyAggregatedVoice_transport	EUS_Carrier PreSelection local interconnection
	EUS_EAA interconnection - BGC Fixed to FOLO
	EUS_EAA interconnection - BGC Fixed to MOLO
	EUS_EAA interconnection - (M)FOLO to BGC Fixed
	EUS_IAA interconnection - MOLO to BGC Fixed
	EUS_IAA interconnection - BGC Fixed to MOLO
	EUS_Local interconnection - FOLO to BGC Fixed
	EUS_MVAS - BGC Fixed
	NLS4_1_BVAS - BGC Fixed
	NLS4_1_EAA BGC Fixed_On net Voice
	NLS4_1_IAA BGC Fixed_On net Voice
	NLS4_1_IAA interconnection - BGC Fixed to FOLO
	NLS4_1_IAA interconnection - FOLO to BGC Fixed
	NLS4_1_Incoming International Traffic - BGC Fixed
	NLS4_1_Local BGC Fixed_On net Voice
	NLS4_1_Outgoing International Traffic - BGC Fixed
NLS4_0_SwitchedVoice_transport_CAЕ_CAЕ	EUS_BGC Fixed National Transit (M)OLO traffic EAA interconnection
	EUS_EAA interconnection - BGC Fixed to FOLO
	EUS_EAA interconnection - BGC Fixed to MOLO
	EUS_EAA interconnection - (M)FOLO to BGC Fixed
	NLS4_1_EAA BGC Fixed_On net Voice
	NLS4_1_Transit International (M)OLO Traffic EAA
NLS4_0_SwitchedVoice_transport_LEX_CAЕ	EUS_EAA interconnection - BGC Fixed to FOLO
	EUS_EAA interconnection - BGC Fixed to MOLO
	EUS_EAA interconnection - (M)FOLO to BGC Fixed
	EUS_IAA interconnection - MOLO to BGC Fixed
	EUS_IAA interconnection - BGC Fixed to MOLO
	EUS_MVAS - BGC Fixed

	NLS4_1_BVAS - BGC Fixed
	NLS4_1_EAA BGC Fixed_On net Voice
	NLS4_1_IAA BGC Fixed_On net Voice
	NLS4_1_IAA interconnection - BGC Fixed to FOLO
	NLS4_1_IAA interconnection - FOLO to BGC Fixed
	NLS4_1_Incoming International Traffic - BGC Fixed
	NLS4_1_Outgoing International Traffic - BGC Fixed
NLS4_0_Voice_traffic_AreaLevel_Aggregate_Deaggregate	EUS_BGC Fixed National Transit (M)OLO traffic EAA interconnection
	EUS_Carrier PreSelection IAA interconnection
	EUS_EAA interconnection - BGC Fixed to FOLO
	EUS_EAA interconnection - BGC Fixed to MOLO
	EUS_EAA interconnection - (M)FOLO to BGC Fixed
	EUS_IAA interconnection - MOLO to BGC Fixed
	EUS_IAA interconnection - BGC Fixed to MOLO
	EUS_MVAS - BGC Fixed
	NLS4_1_BVAS - BGC Fixed
	NLS4_1_EAA BGC Fixed_On net Voice
	NLS4_1_IAA BGC Fixed_On net Voice
	NLS4_1_IAA interconnection - BGC Fixed to FOLO
	NLS4_1_IAA interconnection - FOLO to BGC Fixed
	NLS4_1_Incoming International Traffic - BGC Fixed
	NLS4_1_Outgoing International Traffic - BGC Fixed
	NLS4_1_Transit International (M)OLO Traffic EAA
NLS4_0_Voice_traffic_AreaLevel_Collect	EUS_Carrier PreSelection IAA interconnection
	EUS_EAA interconnection - BGC Fixed to FOLO
	EUS_EAA interconnection - BGC Fixed to MOLO
	EUS_IAA interconnection - BGC Fixed to MOLO
	EUS_MVAS - BGC Fixed
	NLS4_1_EAA BGC Fixed_On net Voice
	NLS4_1_IAA interconnection - BGC Fixed to FOLO
	NLS4_1_Outgoing International Traffic - BGC Fixed
NLS4_0_Voice_traffic_AreaLevel_Complete	NLS4_1_BVAS - BGC Fixed
	NLS4_1_IAA BGC Fixed_On net Voice
NLS4_0_Voice_traffic_AreaLevel_PointOfInterconnect	EUS_BGC Fixed National Transit (M)OLO traffic EAA interconnection

	EUS_BGC Fixed National Transit (M)OLO traffic IAA interconnection
	EUS_EAA interconnection - BGC Fixed to FOLO
	EUS_EAA interconnection - BGC Fixed to MOLO
	EUS_EAA interconnection - (M)FOLO to BGC Fixed
	EUS_IAA interconnection - MOLO to BGC Fixed
	EUS_IAA interconnection - BGC Fixed to MOLO
	NLS4_1_IAA interconnection - BGC Fixed to FOLO
	NLS4_1_IAA interconnection - FOLO to BGC Fixed
	NLS4_1_Incoming International Traffic - BGC Fixed
	NLS4_1_Outgoing International Traffic - BGC Fixed
	NLS4_1_Transit International (M)OLO Traffic EAA
	NLS4_1_Transit International (M)OLO Traffic IAA
NLS4_0_Voice_traffic_AreaLevel_Terminate	EUS_EAA interconnection - (M)FOLO to BGC Fixed
	EUS_IAA interconnection - MOLO to BGC Fixed
	NLS4_1_EAA BGC Fixed_On net Voice
	NLS4_1_IAA interconnection - FOLO to BGC Fixed
	NLS4_1_Incoming International Traffic - BGC Fixed
NLS4_0_Voice_traffic_AreaLevel_Transit	EUS_BGC Fixed National Transit (M)OLO traffic EAA interconnection
	EUS_BGC Fixed National Transit (M)OLO traffic IAA interconnection
	EUS_EAA interconnection - BGC Fixed to FOLO
	EUS_EAA interconnection - BGC Fixed to MOLO
	EUS_EAA interconnection - (M)FOLO to BGC Fixed
	NLS4_1_Transit International (M)OLO Traffic EAA
	NLS4_1_Transit International (M)OLO Traffic IAA
NLS4_0_Voice_traffic_Local_Aggregate_Deaggregate	EUS_Carrier PreSelection IAA interconnection
	EUS_EAA interconnection - BGC Fixed to FOLO
	EUS_EAA interconnection - BGC Fixed to MOLO
	EUS_EAA interconnection - (M)FOLO to BGC Fixed
	EUS_IAA interconnection - MOLO to BGC Fixed
	EUS_IAA interconnection - BGC Fixed to MOLO
	EUS_MVAS - BGC Fixed

	NLS4_1_BVAS - BGC Fixed
	NLS4_1_EAA BGC Fixed_On net Voice
	NLS4_1_IAA BGC Fixed_On net Voice
	NLS4_1_IAA interconnection - BGC Fixed to FOLO
	NLS4_1_IAA interconnection - FOLO to BGC Fixed
	NLS4_1_Incoming International Traffic - BGC Fixed
	NLS4_1_Outgoing International Traffic - BGC Fixed
NLS4_0_Voice_traffic_Local_Collect	EUS_Carrier PreSelection IAA interconnection
	EUS_Carrier PreSelection local interconnection
	EUS_EAA interconnection - BGC Fixed to FOLO
	EUS_EAA interconnection - BGC Fixed to MOLO
	EUS_IAA interconnection - BGC Fixed to MOLO
	EUS_MVAS - BGC Fixed
	NLS4_1_BVAS - BGC Fixed
	NLS4_1_EAA BGC Fixed_On net Voice
	NLS4_1_IAA BGC Fixed_On net Voice
	NLS4_1_IAA interconnection - BGC Fixed to FOLO
	NLS4_1_Outgoing International Traffic - BGC Fixed
NLS4_0_Voice_traffic_Local_Complete	NLS4_1_Local BGC Fixed_On net Voice
NLS4_0_Voice_traffic_Local_PointOfInterconnect	EUS_Local interconnection - FOLO to BGC Fixed
	NLS4_1_Incoming International Traffic - BGC Fixed
	NLS4_1_Outgoing International Traffic - BGC Fixed
NLS4_0_Voice_traffic_Local_Terminate	EUS_EAA interconnection - (M)FOLO to BGC Fixed
	EUS_IAA interconnection - MOLO to BGC Fixed
	EUS_Local interconnection - FOLO to BGC Fixed
	NLS4_1_BVAS - BGC Fixed
	NLS4_1_EAA BGC Fixed_On net Voice
	NLS4_1_IAA BGC Fixed_On net Voice
	NLS4_1_IAA interconnection - FOLO to BGC Fixed
	NLS4_1_Incoming International Traffic - BGC Fixed

7.8.3 Contributors to the application services

TV services

The broadcast TV application service is the result of the video streaming network stage function (NSF_BroadcastTV) and the nation wide broadcast using the SDH clusters (NLS2.0_xxxBackboneCapacityXXX and NLS2_1_xxxBackboneCapacity_Ethernet>=10M) and simultaneously the multicast features of the Ethernet/MPLS regional clusters (NLS2.1_Backbone_MulticastVPLS_IntraRegion) combined with the express pseudowires (NLS2_1_Backbone_Pseudowire_InterCity) in order to reach all regional clusters.

Contributor to NLS4_0_BroadcastTV	Driver
NLS2_0_InterCityBackboneCapacity<2M	Bandwidth consumed (Mbit/s)
NLS2_0_InterCityBackboneCapacity=2M	Bandwidth consumed (Mbit/s)
NLS2_0_InterCityBackboneCapacity>2M	Bandwidth consumed (Mbit/s)
NLS2_0_IntraAreaBackboneCapacity<2M	Bandwidth consumed (Mbit/s)
NLS2_0_IntraAreaBackboneCapacity=2M	Bandwidth consumed (Mbit/s)
NLS2_0_IntraAreaBackboneCapacity>2M	Bandwidth consumed (Mbit/s)
NLS2_0_IntrazonalBackboneCapacity<2M	Bandwidth consumed (Mbit/s)
NLS2_0_IntrazonalBackboneCapacity=2M	Bandwidth consumed (Mbit/s)
NLS2_0_LocalBackboneCapacity>2M	Bandwidth consumed (Mbit/s)
NLS2_1_Backbone_MulticastVPLS_IntraRegion	direct
NLS2_1_Backbone_Pseudowire_InterCity	TotalPeakBandwidth_used(Gbps)
NLS2_1_BackboneCapacity_Ethernet>=10M	Bandwidth consumed (Mbit/s)
NLS2_1_InterCityBackboneCapacity_Ethernet>=10M	Bandwidth consumed (Mbit/s)
NSF_BroadcastTV	Nbr_TV_users

Similarly, the Video On Demand service is the result of Video Movie servers (NSF_VoD) delivering the content and the transport services towards the closest local node to the customer (Broadband aggregator). The transport is realized on the Ethernet/MPLS network (through the NLS3_VOD_IP_Collection) and on the transmission network by means of some last mile backhaul capacity (NLS2.0_...BackboneCapacity>2M).

Contributor to NLS4_0_VoD	Driver
NLS2_0_InterCityBackboneCapacity>2M	Bandwidth consumed (Mbit/s)
NLS2_0_IntraAreaBackboneCapacity>2M	Bandwidth consumed (Mbit/s)
NLS2_0_IntrazonalBackboneCapacity>2M	Bandwidth consumed (Mbit/s)
NLS2_0_LocalBackboneCapacity>2M	Bandwidth consumed (Mbit/s)
NLS3_VoD_IP_collection	direct
NSF_VoD	Nbr_TV_users

Voice application services in the access

PSTN and ISDN access services are the result of the voice concentrator function in the closest technical building (local switch or remote unit) and the physical copper connectivity between the customer site and the technical building. In addition, the data connectivity required to transport Voice over IP signaling and traffic to the Voice over IP switching units is also included as a contributor to voice access.

PRA access services do not need a concentrator function (that function is typically realized within the customer site by private switches) but merely a voice transport link to the local switch. This one is obtained directly from layer 2.0 transport segments and local tails.

Hereunder a summary of the contributors to voice access together with the drivers used to determine their level of involvement in the service

Voice access service	Contributor	Driver Name
NLS4_0_ISDN_access	NLS1_0_Continue_Raw_Copper	Nbr_of_used_pairs
	NLS1_0_Raw_Copper	Nbr_of_used_pairs
	NSF_ISDN_NetworkTermination	Nbr_of_accesses
	NSF_ISDN_Voice_concentrator	Nbr_lines_inUse
NLS4_0_PSTN_access	NLS1_0_Continue_Raw_Copper	Nbr_of_used_pairs
	NLS1_0_Raw_Copper	Nbr_of_used_pairs
	NLS3_VoIP_IP_collection	Direct
	NSF_PairGainSystem	Direct
	NSF_PSTN_Voice_concentrator	Nbr_lines_inUse
NLS4_0_ISDN-PRA_access	NLS2_0_InterCityBackboneCapacity=2M	Bandwidth consumed (Mbit/s)
	NLS2_0_IntraAreaBackboneCapacity=2M	Bandwidth consumed (Mbit/s)
	NLS2_0_IntrazonalBackboneCapacity=2M	Bandwidth consumed (Mbit/s)
	NLS2_0_LocalBackboneCapacity=2M	Bandwidth consumed (Mbit/s)
	NLS2_0_LocalTailCapacity	Bandwidth consumed (Mbit/s)
	NSF_ISDN_Primary_Access	Nbr_lines_inUse

Voice application services in the backbone (see picture Figure 25 - Switching Network)

The services in the group “Access to VoiceCallHandling” allow to access the switching matrix and call handling , they are realized by ports to the switch (a switch port concentrates the voice circuits from/to the switching matrix). The switching ports (trunks) can be those of a local switch or of a transit switch .

For the case of interconnection with other operators (NLS4_o_Voice_traffic_AreaLevel_PointOfInterconnect, NLS4_o_Voice_traffic_Local_PointOfInterconnect) , the charging function of the switch is also exercised in order to allow for interoperator billing.

In summary the contributors are distributed using following drivers:

Network functions used to realize Access to VoiceCallHandling services	Driver used to attribute network functions to access to VoiceCallHandling services
NSF_Voice_call_CAE_charging	RoutedMin
NSF_Voice_call_CAE_Trunks	TimeSlot_capacity_used
NSF_Voice_call_Local_charging	RoutedMin
NSF_Voice_call_Local_Trunks	TimeSlot_capacity_used

The services in the group “VoiceCallHandling” result from three network stage functions:
NSF_Voice_call_CAE_Processing

NSF_Voice_call_Local_Processing
NSF_Voice_call_Local_charging

The driver used is “routed minutes” and it consists in determining the average nbr of times (=routing factor) a voice call handling type is using the network functions . The routed minutes result from multiplication of the routing factor with the amount of calls (expressed in minutes) exercising that voice call handling type.

Network function		Driver Name
NSF_Voice_call_CAE_Processing	NLS4_0_Voice_traffic_AreaLevel_Collect	RoutedMin
	NLS4_0_Voice_traffic_AreaLevel_Complete	RoutedMin
	NLS4_0_Voice_traffic_AreaLevel_Terminate	RoutedMin
	NLS4_0_Voice_traffic_AreaLevel_Transit	RoutedMin
NSF_Voice_call_Local_charging	NLS4_0_Voice_traffic_Local_Collect	RoutedMin
	NLS4_0_Voice_traffic_Local_Complete	RoutedMin
NSF_Voice_call_Local_Processing	NLS4_0_Voice_traffic_Local_Collect	RoutedMin
	NLS4_0_Voice_traffic_Local_Complete	RoutedMin
	NLS4_0_Voice_traffic_Local_Terminate	RoutedMin

The services in the group “Voice transport” are emanating from layer 2.0 Backbone transport capacity (<=2M) which are distributed according to the consumed bandwidth.

Contributor to NLS4_x	Driver	NLS4_x element
NLS2_0_LocalBackboneCapacity<2M	Bandwidth consumed (Mbit/s)	NLS4_0_FixedSwitchedVoice_transport_National_offnet
		NLS4_0_SwitchedVoice_transport_LEX_CAE
		NLS4_1_Outgoing International Traffic - BGC Fixed
		NLS4_0_SwitchedVoice_transport_CAE_CAE
		NLS4_0_SwitchedVoice_transport_CAE_MSC
		NLS4_0_SwitchedVoice_transport_LEX_MSC
NLS2_0_LocalBackboneCapacity=2M	Bandwidth consumed (Mbit/s)	NLS4_0_ISDN-PRA_access
		NLS4_0_RemotelyAggregatedVoice_transport
		NLS4_0_SwitchedVoice_transport_CAE_CAE
		NLS4_0_SwitchedVoice_transport_LEX_CAE
NLS2_0_IntrazonalBackboneCapacity<2M	Bandwidth consumed (Mbit/s)	NLS4_0_FixedSwitchedVoice_transport_National_offnet
		NLS4_0_SwitchedVoice_transport_LEX_CAE
		NLS4_1_Outgoing International Traffic - BGC Fixed
		NLS4_0_SwitchedVoice_transport_CAE_CAE
		NLS4_0_SwitchedVoice_transport_CAE_MSC
NLS2_0_IntrazonalBackboneCapacity=2M	Bandwidth consumed (Mbit/s)	NLS4_0_SwitchedVoice_transport_LEX_MSC
		NLS4_0_ISDN-PRA_access
		NLS4_0_RemotelyAggregatedVoice_transport
NLS2_0_IntraAreaBackboneCapacity<2M	Bandwidth consumed (Mbit/s)	NLS4_0_SwitchedVoice_transport_LEX_CAE
		NLS4_0_FixedSwitchedVoice_transport_National_offnet

		NLS4_1_Outgoing International Traffic - BGC Fixed
		NLS4_0_SwitchedVoice_transport_CAE_CAE
		NLS4_0_SwitchedVoice_transport_CAE_MSC
		NLS4_0_SwitchedVoice_transport_LEX_MSC
		NLS4_0_SwitchedVoice_transport_LEX_CAE
NLS2_0_IntraAreaBackboneCapacity=2M	Bandwidth consumed (Mbit/s)	NLS4_0_ISDN-PRA_access
		NLS4_0_RemotelyAggregatedVoice_transport
		NLS4_0_SwitchedVoice_transport_CAE_CAE
		NLS4_0_SwitchedVoice_transport_LEX_CAE
NLS2_0_InterCityBackboneCapacity<2M	Bandwidth consumed (Mbit/s)	NLS4_0_FixedSwitchedVoice_transport_National_offnet
		NLS4_1_Outgoing International Traffic - BGC Fixed
		NLS4_0_SwitchedVoice_transport_CAE_CAE
		NLS4_0_SwitchedVoice_transport_CAE_MSC
		NLS4_0_SwitchedVoice_transport_LEX_MSC
		NLS4_0_SwitchedVoice_transport_LEX_CAE
NLS2_0_InterCityBackboneCapacity=2M	Bandwidth consumed (Mbit/s)	NLS4_0_ISDN-PRA_access
		NLS4_0_SwitchedVoice_transport_CAE_CAE
		NLS4_0_SwitchedVoice_transport_LEX_CAE
NLS2_0_LocalTail<2M	Nbr_of_Customer_sites	NLS4_0_FixedSwitchedVoice_transport_National_offnet
NLS2_0_LocalTail=2M	Nbr_of_Customer_sites	NLS4_0_ISDN-PRA_access

The services in the group “VAS application” are in fact directly identified with a network function:

NSF_Advanced_Number_Translation_CallHandling	NLS4_0_Advanced_Number_Translation_CallHandling	direct
NSF_CallerIdentity_CallHandling	NLS4_0_CallerIdentity_CallHandling	direct
NSF_CallingCard_CallHandling	NLS4_0_CallingCard_CallHandling	direct
NSF_InteractiveVoiceResponse_CallHandling	NLS4_0_InteractiveVoiceResponse_CallHandling	direct
NSF_MessageWaitingIndicator_Inserting	NLS4_0_MessageWaitingIndicator_Inserting	direct
NSF_OtherAdvanced_CallHandling	NLS4_0_OtherAdvanced_CallHandling	direct
NSF_PrepaidCallingCard_CallHandling	NLS4_0_PrepaidCallingCard_CallHandling	direct
NSF_Service_Announcements_Playing	NLS4_0_Service_Announcements_Playing	direct
NSF_Televoiting_CallHandling	NLS4_0_Televoiting_CallHandling	direct
NSF_VirtualPrivateNetwork_CallHandling	NLS4_0_VirtualPrivateNetwork_CallHandling	direct
NSF_VoiceFeatures_SelfManaging	NLS4_0_VoiceFeatures_SelfManaging	direct
NSF_Voicemail&Messaging	NLS4_0_Voicemail&Messaging	direct
NSF_WakeUp_CallHandling	NLS4_0_WakeUp_CallHandling	direct

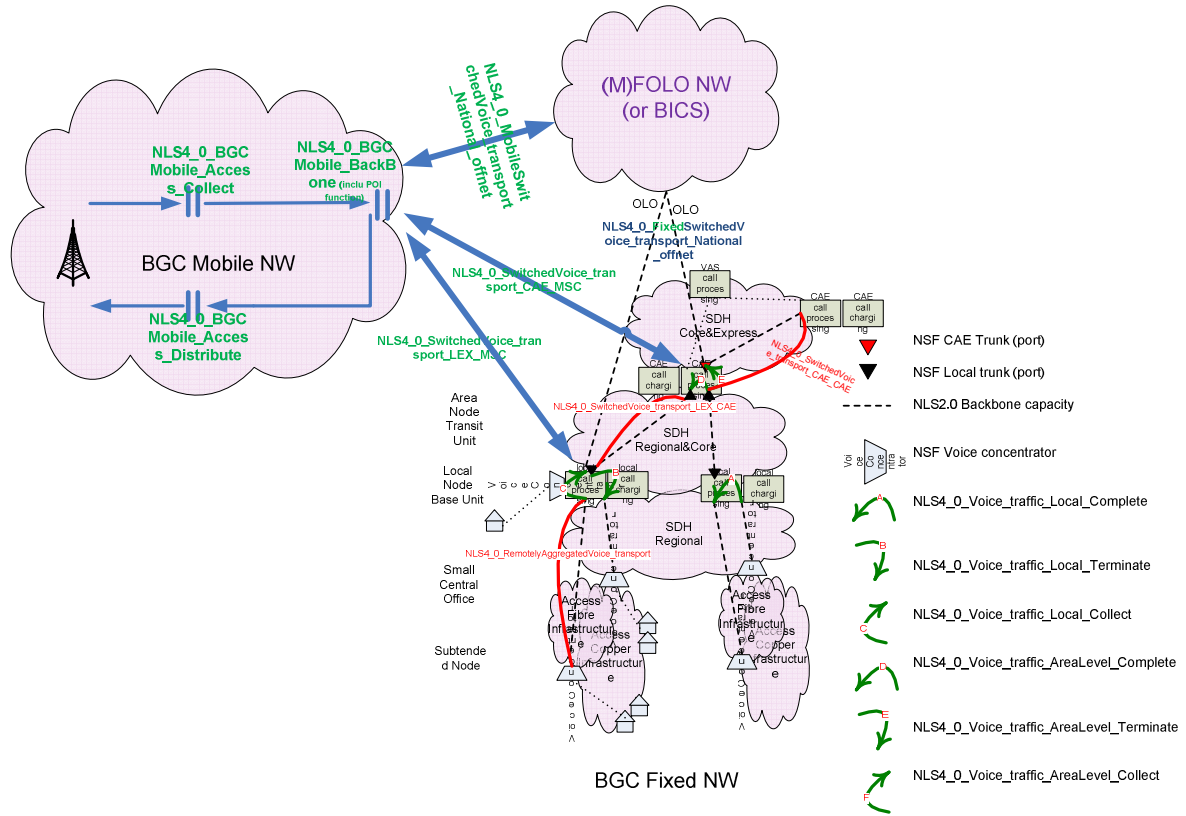

Figure 25 - Switching Network

7.9 Allocation of Network and customer-related activities of 50_SDE :

Activity	Division	Teamgroup	Driver
5.2.13. Fixed NW Access Outside - copper work for customer	50_SDE	COP-CFOx-CAB	DU
5.3.6. Fixed NW Access Outside Maintenance & Repair - Cable	50_SDE	COP-CFOx-CAB	DU
2.6.6. Dispatch, monitor and close provisioning Cu splicing work orders related to the introduction cable	50_SDE	COP-CFOx-IDC-CABLE	DU
3.5.6. Dispatch, monitor and close Cu splicing work orders related to the repair of cable network	50_SDE	COP-CFOx-IDC-CABLE	DU
2.6.3. Dispatch, monitor and close provisioning work orders (not related to the cable)	50_SDE	COP-CFOx-IDC-MASS	DU
3.5.3. Dispatch, monitor and close repair work orders (not related to the cable)	50_SDE	COP-CFOx-IDC-MASS	DU
2.6.3. Dispatch, monitor and close provisioning work orders (not related to the cable)	50_SDE	COP-CFOx-IDC-PROF	DU
3.5.3. Dispatch, monitor and close repair work orders (not related to the cable)	50_SDE	COP-CFOx-IDC-PROF	DU
2.6.3. Dispatch, monitor and close provisioning work orders (not related to the cable)	50_SDE	COP-CFOx-IDC-Support	DU
3.5.3. Dispatch, monitor and close repair work orders (not related to the cable)	50_SDE	COP-CFOx-IDC-Support	DU
2.7.3. Execute field provisioning	50_SDE	COP-CFOx-MAS	DU
3.6.3. Execute field repair	50_SDE	COP-CFOx-MAS	DU
2.7.3. Execute field provisioning	50_SDE	COP-CFOx-PRF	DU
3.6.3. Execute field repair	50_SDE	COP-CFOx-PRF	DU
3.4.1. Execute fault handling & remote repair - Mass	50_SDE	COP-CRO-CHC	Working hours
2.5.1. Execute remote provisioning - Mass	50_SDE	COP-CRO-IAC	FTE
2.5.1. Execute remote provisioning - Mass	50_SDE	COP-CFOx-PCD	FTE

2.8.4. Manage projects related to the provisioning of telecom & IT solutions - Prof	50_SDE	COP-EIS-NUC-CNN	Configured nodes
2.9.1. ICT service provisioning	50_SDE	COP-EIS-NUC-ICT	Revenue
2.10.1. Mobile service provisioning	50_SDE	COP-EIS-NUC-MCC	FTE
2.5.2. Execute remote provisioning - Prof	50_SDE	COP-EIS-CNN	Configured nodes
3.4.2 Execute fault handling & remote repair - Prof	50_SDE	COP-EIS-ISD-RPC	Working hours
3.2.2. Provide Customer Service/SLA management - Prof	50_SDE	COP-EIS-SID	Customers
2.9.2. ICT Data Center provisioning for Customer	50_SDE	COP-EIS-SIN-SDC	Revenue
3.7.3. ICT Data Center repair for Customer	50_SDE	COP-EIS-SIN-SDC	Revenue
2.9.3. ICT Security & System Integration provisioning for Customer	50_SDE	COP-EIS-SIN-ASO	Revenue
3.7.4. ICT Security & System Integration repair for Customer	50_SDE	COP-EIS-SIN-ASO	Revenue
2.9.3. ICT Security & System Integration provisioning for Customer	50_SDE	COP-EIS-SIN-SEC	Revenue
3.7.4. ICT Security & System Integration repair for Customer	50_SDE	COP-EIS-SIN-SEC	Revenue
2.9.3. ICT Security & System Integration provisioning for Customer	50_SDE	COP-EIS-SIN-ZOD	Revenue
3.7.4. ICT Security & System Integration repair for Customer	50_SDE	COP-EIS-SIN-ZOD	Revenue
3.7.1. ICT service repair - 1st handling	50_SDE	COP-EIS-ISD-USD	Revenue
3.7.2. ICT monitoring & service repair - 2nd handling	50_SDE	COP-EIS-ISD-ROC/SSC	Revenue
3.8.1. Mobile services support	50_SDE	COP-EIS-ISD-MSS	FTE
5.2.1. Fixed NW Plan Backbone Inside plant works and document	50_SDE	IDO-FXx-BND-EQE	FTE
5.2.2. Fixed NW Plan Access Inside plant works and document	50_SDE	IDO-FXx-BND-EQE	FTE
5.2.8. Fixed NW Plan outside plant works and document	50_SDE	IDO-FXx-BND-IDE	FTE
5.2.9. NW Plan plant works, Solution design & Engineering for VHR/Industrial zonings	50_SDE	IDO-FXx-BND-IDE-VHR	Direct
5.2.9. NW Plan plant works, Solution design & Engineering for VHR/Industrial zonings	50_SDE	IDO-FXx-BND-EQE-VHR	Direct

5.2.3. Fixed NW Backbone Inside Installation	50_SDE	IDO-FXx-IMR-xxx	FTE
5.3.1. Fixed NW Backbone Inside Maintenance & Repair	50_SDE	IDO-FXx-IMR-xxx	FTE
5.3.2. Fixed NW Access Inside Maintenance & Repair	50_SDE	IDO-FXx-IMR-xxx	FTE
5.2.4. Fixed NW Access Inside Installation	50_SDE	IDO-FXx-IMR-xxx	FTE
5.2.10. Fixed NW (Supervision, coordination and inventory) Outside construction	50_SDE	IDO-FXx-LPE-xxx	FTE
5.3.4. Fixed NW Access Outside Maintenance & Repair - FO/ROP	50_SDE	IDO-FXx-OPT-OUT	FTE
5.2.12. NW Access Outside - VHR/Radio for customer	50_SDE	IDO-FXx-OPT-VHR	FTE
5.3.5. Fixed NW Access Outside Maintenance & Repair - VHR/Radio	50_SDE	IDO-FXx-OPT-VHR	FTE
5.2.12. NW Access Outside - VHR/Radio for customer	50_SDE	IDO-FXx-OPT-Radio	FTE
5.3.5. Fixed NW Access Outside Maintenance & Repair - VHR/Radio	50_SDE	IDO-FXx-OPT-Radio	FTE
5.2.20. Mobile NW Planification, Configuration & (supervision) Construction	50_SDE	IDO-MOB-xxx	FTE
5.2.20. Mobile NW Planification, Configuration & (supervision) Construction	50_SDE	IDO-FXx-WOS	FTE
5.3.20. Mobile NW Monitoring, Maintenance & Repair	50_SDE	IDO-MOB-xxx	FTE
5.3.20. Mobile NW Monitoring, Maintenance & Repair	50_SDE	IDO-FXx-WOS	FTE
5.1.1. NW Infrastructure Engineering	50_SDE	SDV-NIE-CAT	Effort by technology
5.1.1. NW Infrastructure Engineering	50_SDE	SDV-NIE-CPE	Effort by technology
5.1.1. NW Infrastructure Engineering	50_SDE	SDV-NIE-DOT	Effort by technology
5.1.1. NW Infrastructure Engineering	50_SDE	SDV-NIE-LAB	Effort by technology
5.1.1. NW Infrastructure Engineering	50_SDE	SDV-NIE-PLE	Effort by technology
5.1.1. NW Infrastructure Engineering	50_SDE	SDV-NIE-WAT	Effort by technology
5.1.2. NW Product & Service Engineering	50_SDE	SDV-PSE-DAC	Effort by technology
5.1.2. NW Product & Service Engineering	50_SDE	SDV-PSE-VID	Effort by technology

5.1.2. NW Product & Service Engineering	50_SDE	SDV-PSE-VCI	Effort by technology
5.1.2. NW Product & Service Engineering	50_SDE	SDV-PSE-MNS	Effort by technology
5.3.11.1. Fixed NW Infrastructure Monitoring	50_SDE	SIO-CSC-NOC-NW	FTE
5.3.11.2. Mobile NW Infrastructure Monitoring	50_SDE	SIO-CSC-NOC-NW	FTE
5.3.11.1. Fixed NW Infrastructure Monitoring	50_SDE	SIO-CSC-SSD	FTE
5.3.11.2. Mobile NW Infrastructure Monitoring	50_SDE	SIO-CSC-SSD	FTE
5.2.7.1. Fixed NW Data&TV&Actg&Authorization Service Remote Configuration	50_SDE	SIO-INO-DSP	FTE
5.2.7.2. Mobile NW Data&TV&Actg&Authorization Service Remote Configuration	50_SDE	SIO-INO-DSP	FTE
5.3.9.1. Fixed NW Data&TV&Actg&Authorization service level Maintenance & Remote Repair	50_SDE	SIO-INO-DSP	FTE
5.3.9.2. Mobile NW Data&TV&Actg&Authorization service level Maintenance & Remote Repair	50_SDE	SIO-INO-DSP	FTE
5.2.5.1. Fixed NW Infrastructure Remote Configuration	50_SDE	SIO-INO-TIO	FTE
5.2.5.2. Mobile NW Infrastructure Remote Configuration	50_SDE	SIO-INO-TIO	FTE
5.3.10.1. Fixed NW Infrastructure Maintenance and Remote Repair	50_SDE	SIO-INO-TIO	FTE
5.3.10.2. Mobile NW Infrastructure Maintenance and Remote Repair	50_SDE	SIO-INO-TIO	FTE
5.2.6.1. Fixed NW Voice Service Remote Configuration	50_SDE	SIO-INO-VSP	FTE
5.2.6.2. Mobile NW Voice Service Remote Configuration	50_SDE	SIO-INO-VSP	FTE
5.3.8.1. Fixed NW Voice service level Maintenance & Remote Repair	50_SDE	SIO-INO-VSP	FTE
5.3.8.2. Mobile NW Voice service level Maintenance & Remote Repair	50_SDE	SIO-INO-VSP	FTE

The cost of NW activities is allocated to NW objects (NE, NSF, CP, NLS...) on which teamgroups have worked via assigned NW activity(ies) :

- The driver quantity used for SDE SDV teamgroup&activity is the effort by technology measured thanks to RAPID.
- The driver quantity used for COP CFO CABLE Mass & Professional teamgroup&activity is the number of related DUs (Dispatching Units) registered in CLARA.
- The driver quantity used for SDE SIO teamgroup&activity is FTE reported in ABB.
- The driver quantity used for SDE IDO teamgroup&activity is FTE reported from LEAD, JMS and CANVAS.

8 Annex I: SRW Flow Acronyms

SRW	Support, Retail, Whole Sale
BIPT	Belgian Institute for Postal services and Telecommunications
BTN	Business TransformatioN
CBU	Consumer Business Unit
CC	Costs Center
CCG	Costs Center Group
CFO	Customer Field Operations
COP	Customer Operations
CP	Costs Pool
CWS	Carrier & WholeSale
EBU	Enterprise Business Unit
FAC	Fully Allocated Costs
HCA	Historical Cost Accounting
IDO	Infrastructure, Deployment & field Operations
MOS	Material Out of Stock
NRA	National Regulatory Authority
REG	(Belgacom) Group Regulatory Affairs
SDE	Service Delivery Engine
SDV	Service Development
SIO	Service center & remote Infrastructure Operations
SMP	Significant Market Power
SOG	Services & Other Goods
S&S	Staff & Support

9 Annex II: Network and IT Flows Acronyms

AC	Asset Class
ADSL	Asymmetric Digital Subscriber Line
ATM	Asynchronous Transfer Mode
BA	Basic Access
BAS	Broadband Access Server
BES	Belgacom European Solutions
BGC	Belgacom
BILAN	Belgacom Interconnection of LANs
BLES	Belgacom LAN Extension Service
BROBA	Belgacom Reference Offer for Bitstream Access
BROTSOLL	Belgacom Reference Offer for Terminating Segment of Leased Line
BVAS	Business Value Added Services
CAE	Coverage Exchange Area
CAPEX	Capital Expenditures
CP	Cost Pool
CPE	Customer Premises Equipment
CPU	Central Processing Unit
CWDM	Coarse Wavelength Division Multiplexing
DACS	Digital Analog Cross-connect System
DCN	Data Communication Network
DSL	Digital Subscriber Line
DSLAM	Digital Subscriber Line Access Multiplexer
DU	Dispatching Unit
DWDM	Dense Wavelength Division Multiplexing
EAA	Extra Access Area
EAL	Ethernet Access Line
EFM	Ethernet First Mile
ESS	Ethernet Service Switch
Ethane	ETHERnet Aggregation NETwork
EUS	End User Service
FAC	Fully Allocated Costs
FIFA	Fast Internet Future Architecture

FTTC	Fiber To The Cabinet
FTTO	Fiber To The Office
Gb	Giga bit
Gbps	Giga bits per second
HW	HardWare
IAA	Intra Access Area
iDTV	interactive Digital TeleVision
IN	Intelligent Network
INCA	Integrated Cost Application
IO	In/Out
IP	Internet Protocol
IPVPN	Internet Protocol Virtual Private Network
ISAM	IP Subscriber Line Access Multiplexer
ISDN	Integrated Services Digital Network
LAN	Local Area Network
LDC	Local Distribution Center
LEX	Local Exchange
LL	Leased Line
LTE	Line Terminating Equipment
Mbit	Mega bit
MOLO	Mobile Other Licensed Operator
MPLS	MultiProtocol Label Switching
MSR	Multi Server Router
MUX	Multiplexer
MVAS	Mass Value Added Services
MWE	MicroWave Equipment
NE	Network Element
NGA	New Generation Access
NGN	New Generation Network
NLS	Network Layer Service
NTE	Network Terminating Equipment
NTP	Network Termination Point
NSF	Network Stage Function
OLO	Other Licensed Operator

OLTE	Optical Line Terminating Equipment
OPEX	Operational Expenditure
OVH	Overhead
PDH	Plesiochronous Digital Hierarchy
PRA	Primary Access
PSTN	Public Switched Telephony Network
QoS	Quality of Service
RAM	Random Access Memory
ROP	Remote Optical Platform
SDH	Synchronous Digital Hierarchy
SDSL	Symmetric Digital Subscriber Line
STM	Synchronous Transport Module
TDM	Time Division Multiplexing
TV	TeleVision
VAS	Value Added Services
VDSL	Very high speed Digital Subscriber Line
VLAN	Virtual Local Area Network
VoD	Video on Demand
VoIP	Voice over Internet Protocol
VP	Virtual Path
VPLS	Virtual Private Local area network Service
VPN	Virtual Private Network
WDM	Wavelength Division Multiplexing